

INFECTION PREVENTION GUIDELINES

E1470

for Healthcare Facilities
in Ethiopia

Ministry of Health
FEBRUARY 2005

INFECTION PREVENTION



INFECTION PREVENTION GUIDELINES

**for Healthcare Facilities
in Ethiopia**

Ministry of Health
Disease Prevention and Control Department

FEBRUARY 2005



FORWARD

In Ethiopia, efforts to improve the healthcare provided to its citizens are increasing in all aspects of health from family planning services to the provision of antiretroviral medication for HIV positive peoples. Foremost among the initiatives currently underway, the protection of patients and healthcare workers from infections inside the hospital has been given particular attention by the Federal Ministry of Health. Indeed, the Ministry is scaling-up its activities related infection prevention and will use all opportunities to strengthen ongoing activities. As in many of its program, the Ministry will utilize available evidence to establish optimal infection prevention practices in health facilities.

In hospital and clinical setting, a high proportion of patients are infected with bacteria and viruses, which cause a continued threat to the health of clients and increase cost to the patient as well as the healthcare system. In addition, without adequate infection prevention practices like proper use of gloves or proper hand washing, healthcare workers are at increased risk of acquiring infection, most commonly HIV/AIDS, Hepatitis A and C, as well as other common bacterial and viral infections. Healthcare workers at risk include all staff of at the facility including nurses, doctors, laboratory technicians, waste management staff and laundry staff.

In the resource constrained settings like many hospitals in Ethiopia, it is difficult to control the infection rates of patients acquiring hospital acquired infections and exposure of the healthcare workers to such infections. Materials, manpower, trainings, policies and guidelines are needed to promote infection prevention practices. Infection Prevention in hospitals and other healthcare settings is a hospital-wide and nation-wide campaign. It involves every aspect of patient care, food preparation, laundry services and hospital waste management. Though it requires commitment and a large amount of materials to implement, outlined in this guidelines are many ways to improve infection prevention practices in these resource constrained settings.

This *National Guideline on Infection Prevention* is intended to act as a resource for healthcare professionals for the guidance on infection prevention practices. The Guideline is developed based on in-country experience and internationally acclaimed and standard recommendations such as those of the U.S. Centers for Disease Control and Prevention recommendations released in 1996. It is geared towards using innovative methods tested and used in all parts of the world to reduce the overhead cost of an Infection Prevention program. It is believed that healthcare workers, program managers and all other stakeholder will use this Guideline effectively to prevent infections from occurring at health facilities. I wish to extend my sincerest thank for all institutions that have contributed to the effort of developing the Guideline.

Dr. Alemayehu Seifu
Disease Prevention and Control Department

ACKNOWLEDGMENTS

The **National Infection Prevention Guidelines for Healthcare Facilities in Ethiopia** was made possible through the unreserved commitment of professionals and institutions listed below:

Dr. Afework Kassa, Federal Ministry of Health, *Chair*

Ato Abebe Shume, Federal Ministry of Health, *Member*

Professor Sileshi Lulseged, US Centers for Disease Control and Prevention in Ethiopia and Addis Ababa University Faculty, *Member*

Dr. Fahimi Mohammed, John Snow International in Ethiopia, *Participant*

Dr. Chandrakant Ruparelia, JHPIEGO, an affiliate of Johns Hopkins University, *Secretary*

Dr. Mohammed Ali, US Centers for Disease Control and Prevention in Ethiopia, *Co-Secretary*

The Ministry of Health acknowledges and expresses its deep appreciation for their contributions.

The Ministry of Health also wishes to acknowledge the contributions of Regional Health Bureaus, various healthcare facilities, healthcare providers and partner organizations who assisted in the development of these Infection Prevention Guidelines.

The Ministry of Health graciously acknowledges the commitment, technical support and expertise of JHPIEGO, an affiliate of Johns Hopkins University, who made the development of these Infection Prevention Guidelines possible. The Ministry of Health would also like to specially thank the US Centers for Disease Control and Prevention in Ethiopia for the technical support and financial assistance provided in the preparation and printing of these Infection Prevention Guidelines.

TABLE OF CONTENTS

Forward	iii
Acknowledgements	iv
List of Figures and Tables	vi
List of Acronyms	vii
CHAPTERS	
1. Infection Prevention Principles	1-1
2. Hand Hygiene	2-1
3. Gloves	3-1
4. Personal Protective Equipment and Drapes	4-1
5. Surgical Antisepsis	5-1
6. Safe Practices in the Operating Room	6-1
7. Safe and Appropriate Use of Injections	7-1
8. Waste Management	8-1
9. Instrument Processing	9-1
10. Processing Linen	10-1
11. Traffic Flow and Activity Pattern	11-1
12. Housekeeping	12-1
13. Clinical Laboratory Services	13-1
14. Blood Bank and Transfusion Services	14-1
15. Isolation Precaution Guidelines for Healthcare Facilities	15-1
16. Preventing Nosocomial Infections	16-1
17. Preventing Infectious Diarrhea and Managing Food and Water Services	17-1
18. Preventing Nosocomial Pneumonia	18-1
19. Management of Infection Prevention Programs	19-1
20. Infection Monitoring (Surveillance) Activities	20-1
Glossary	Glossary-1

LIST OF FIGURES AND TABLES

Table 3-1	Glove Requirements for Common Medical and Surgical Procedures	3-2
Table 3-2	Glove Wearing Guidelines	3-3
Figure 3-1	Cutting the Four Fingers Off a Glove	3-4
Figure 3-2	Putting Surgical Gloves on Both Hands	3-5
Table 4-1	How Personal Protective Equipment Blocks the Spread of Microorganisms	4-1
Table 4-2	Types of Personal Protective Equipment	4-2
Table 5-1	Antiseptic Solutions: Microbiologic Activities and Potential Uses	5-3
Table 6-1	Classification and Indications for PEP	6-2
Table 6-2	Risk Categories and ARV Prophylaxis	6-3
Figure 8-1	Simple Incinerator using Local Materials	8-4
Figure 8-2	Stationary Incinerator	8-4
Figure 8-3	Burial Site for Waste Disposal	8-5
Figure 9-1	Key Steps in Processing Contaminated Instruments, Gloves and Other Items	9-1
Table 9-1	Effectiveness of Methods for Processing Instruments	9-4
Figure 9-2	Example of a HLD Steamer	9-10
Table 9-2	Preparing and Using Chemical Disinfectants	9-12
Table 9-3	Guidelines for Processing Instruments, Surgical Gloves, and Other Items	9-13
Table 15-1	Clinical Syndromes or Conditions to Be Considered for “Empiric Use” of Transmission-Based Precautions	15-4
Table 15-2	Summary of Types of Precautions and Patients Requiring the Precautions	15-5
Table 20-1	Measures Identified as Effective in Investigating Outbreaks	20-3

LIST OF ACRONYMS

AIDS	Acquired Immune Deficiency Syndrome
ARV	Antiretroviral
BSL	Biosafety level
CDC	Centers for Disease Control and Prevention
HBV	Hepatitis B virus
HCV	Hepatitis C virus
HIV	Human Immunodeficiency Virus
HLD	High level disinfection
IAIS	Intra-Amniotic Infection Syndrome
IP	Infection prevention
IUD	Intrauterine device
MOH	Ministry of Health
PEP	Post-exposure prophylaxis
PMTCT	Prevention of Mother-to-Child Transmission
PPE	Personal protective equipment
ppm	parts per million
QUAT	Quaternary ammonium compound
SSI	Surgical site infection
SUD	Single-use device
TST	Time, Steam, Temperature
WHO	World Health Organization

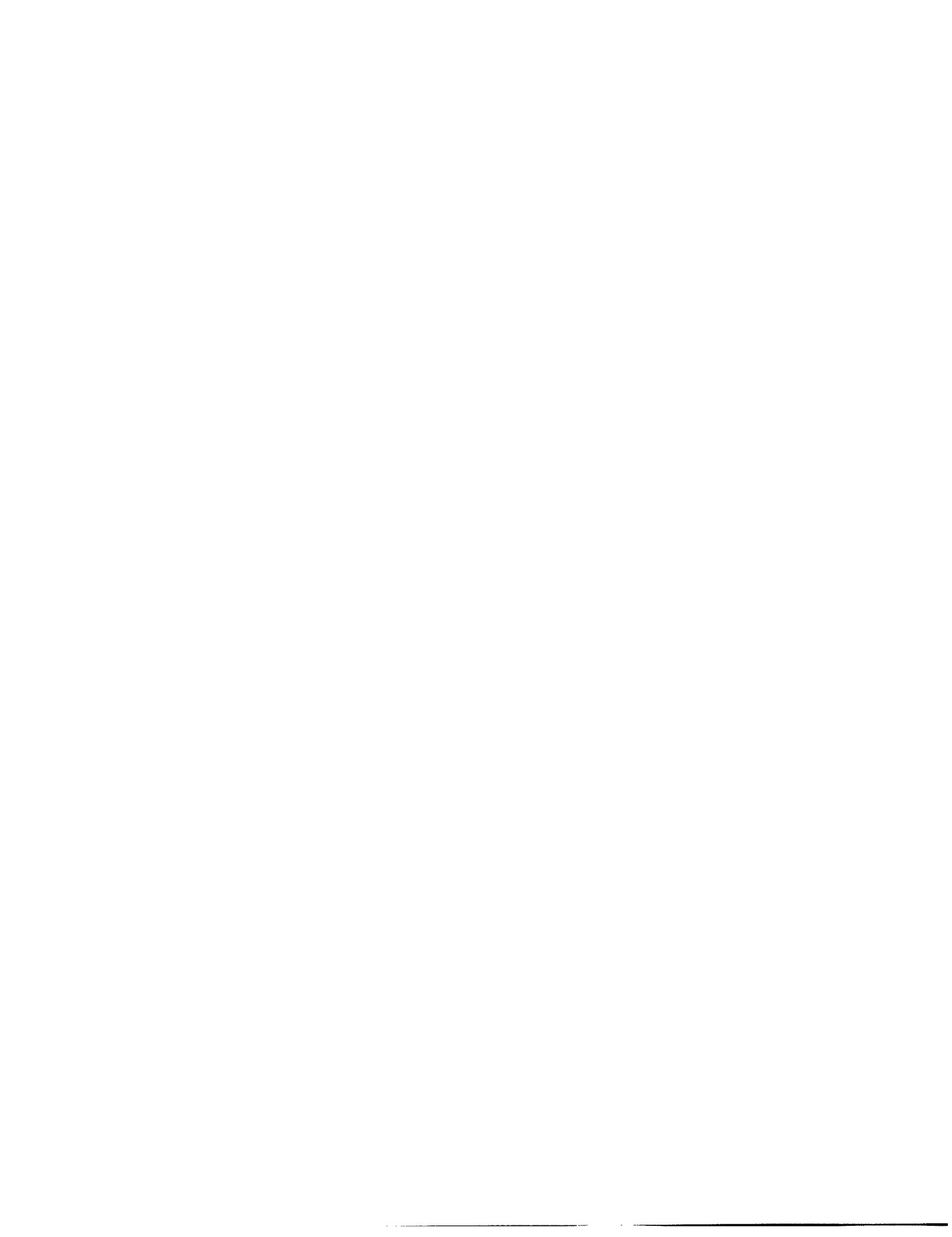

CHAPTER 1

INFECTION PREVENTION PRINCIPLES

The IP practices described in these guidelines are intended for use in all types of medical and healthcare facilities—from large urban hospitals to small rural clinics. They are designed to minimize costs and the need for expensive and often fragile equipment while at the same time assuring a high degree of safety.

Objectives: Infection Prevention in healthcare facilities has two primary objectives:

- To prevent infections when providing any type of service that involves noninvasive as well as invasive procedures (e.g., injections, intravascular infusions, urinary catheterization, wound management, IUD insertion, surgical procedures).
- To minimize the risk of transmitting serious infections such as HIV, and Hepatitis B and C not only among clients but also to service providers, including cleaning and housekeeping personnel.

The principles of infection prevention described below are based on the guidelines issued by Centers for Disease Control and Prevention, Atlanta, Georgia in 1996 and are equally applicable in Ethiopia. The guidelines involve a two level approach:

- Standard Precautions, which apply to all clients and patients attending healthcare facilities, and
- Transmission-Based Precautions, which apply to hospitalized patients and also non-hospitalized patients where route of transmission is clearly known.

PRINCIPLES OF INFECTION PREVENTION

The recommended IP practices are based on the following principles:

- Consider every person potentially infectious and susceptible to infection.
- Washing hands before and after any procedure is the most practical procedure for preventing cross-contamination (person-person).
- Wearing gloves before touching anything potentially infectious and wet—broken skin, mucous membrane, blood, body fluids, secretions or excretion or soiled instrument and other items—or before performing invasive procedures.
- Using physical barriers including personal protective equipment, if splashes or spills of any blood, body fluids, secretions or excretions are anticipated.
- Using antiseptic agents for cleansing the skin or mucous membrane prior to surgery, cleaning wounds, or doing handrubs or surgical handscrub.
- Using safe work practices, such as not recapping or bending needles, safely passing sharp instruments, and disposing of sharps in puncture resistant containers.
- Processing instruments and other items that come in contact with blood, body fluids, secretions and excretions (decontamination, cleaning, and sterilization or high-level disinfection).

- Routinely cleaning and disinfecting equipment and furniture in patient care areas.
- Disposing contaminated materials and contaminated waste properly.
- Isolating patients only if secretions or excretions cannot be contained.

Proper infection prevention practices are fundamental to quality of care, and essential to protect healthcare workers, patients, and communities. Particularly in a country such as Ethiopia, where the prevalence of serious infectious diseases such as Hepatitis B and HIV is so high, and preventive interventions for both these diseases are minimal, failure to follow proper infection prevention practices puts healthcare workers, patients and the communities at tremendous risk.

Good infection prevention practices include:

- Washing hands before and after contact with every client, even if gloves are worn
- Wearing gloves and using appropriate personal protective equipment when contact with any mucous membranes, blood, body fluids, secretions and excretions is anticipated
- Proper handling of sharps—especially hypodermic needles, scalpels etc.—to protect healthcare workers, cleaners and the community
- Proper handling of specimens (blood, tissue, excretions and secretions)
- Decontaminating all instruments and surfaces, that have come in contact with body fluids or mucous membranes, for 10 minutes in a 0.5% chlorine solution
- Thorough washing and rinsing of instruments and items or surfaces to remove any caked blood or residual tissue before sterilization or high-level disinfection
- Properly sterilizing or, when sterilization is not possible, carrying out high-level disinfection of instruments
- Proper storing and handling of processed instruments
- Managing traffic flow, and activity pattern in wards, procedure areas and operating theater
- Minimizing preoperative stay in the healthcare facility
- Following proper isolation precautions for highly infectious patients if secretions or excretions cannot otherwise be contained
- Managing safe and proper disposal of wastes
- Reporting accidental exposure to blood and body fluids including needle stick injuries and proper management of accidental injuries
- Providing continuous supportive supervision and monitoring of infection prevention practices and infection rates

Proper infection prevention practices break the disease transmission cycle. This is achieved by:

- Reducing the number of infection causing microorganisms present (e.g., simple handwashing, cleaning of instruments);
- Killing or inactivating infection causing microorganisms (e.g., handwashing with a waterless alcohol preparation, decontamination);

- Creating barriers to prevent infectious agents from spreading (e.g., wearing gloves or personal protective equipment); or
- Reducing or eliminating risky practices (e.g., using hands-free technique, using disposable gloves and syringes etc.).

The decisions regarding selecting an infection prevention practice or process to use (e.g., sterilization of medical instrument versus high-level disinfection, of gloves and other items) when caring for the patients will be based on three categories of potential infection risk as proposed by Spaulding in 1968.

The Spaulding categories are summarize below:

- **Critical:** These items and practices affect normally sterile tissues or the blood system and represent the highest level of infection risk. Failure to provide management of sterile or, where appropriate, high-level disinfected items, is most likely to result in infections that are most serious.
- **Semi-critical:** These items and practices are second in importance and affect mucous membranes and small areas of nonintact skin. Management needs are considerable and require knowledge and skills in:
 - Handling many invasive devices (e.g., gastrointestinal endoscopes and vaginal specula),
 - Performing decontamination, cleaning and high-level disinfection, and
 - Gloving for personnel who touch mucous membranes and nonintact skin.
- **Noncritical:** Management of items and practices that involve intact skin and represent the lowest level of risk. Some are more important than others. Poor management of non-critical items such as overuse of examination gloves often consumes a major share of resources while providing only limited benefits.

There is no indication for using gloves if bare hands are not likely to come in contact with any blood or body fluids (except sweat).

The healthcare team should make decisions regarding the infection prevention practices and items to be used based on the Spaulding classification given above.

REFERENCES

- Lynch P et al. 1997. Infection Prevention with Limited Resources. ETNA Communications: Chicago.
- Spaulding EH. 1968. Chemical disinfection of medical and surgical materials, in Disinfection, Sterilization and Preservation. Lawrence CA et al (eds). Lea & Febiger: Philadelphia, pp 437–446.
- Garner JS and The Hospital Infection Control Practices Advisory Committee (HICPAC). 1996. Guideline for isolation precautions in hospitals. Infect Control Hosp Epidemiol 17(1): 53–80 and Am J Infect Control 24(1):4–52.



CHAPTER 2

HAND HYGIENE

Hand hygiene is the single most important infection prevention procedure.

Proper hand hygiene and the use of protective gloves, whether in the operating room for surgery or in housekeeping for handling contaminated materials, are key components in minimizing the spread of disease and in maintaining an infection-free environment.

Appropriate hand hygiene must be carried out:

- Before examining (coming in direct contact with) a client/patient
- Before putting on sterile or high-level disinfected surgical gloves, or examination gloves
- After any situation in which hands may be contaminated, such as:
 - Handling contaminated objects, including used instruments
 - Touching mucous membranes, blood, body fluids, secretions or excretions (except sweat)
- After removing gloves

HAND HYGIENE TECHNIQUES

Routine Handwashing

The purpose of handwashing is to mechanically remove soil and debris from skin and reduce the number of transient microorganisms. Handwashing with plain soap and clean¹ water is as effective in cleaning hands and removing transient microorganisms as washing with antimicrobial soaps and causes less skin irritation.

For appropriate handwashing:

- Thoroughly wet hands.
- Apply a handwashing agent (plain soap or detergent).
- Vigorously rub all areas of hands and fingers for 10–15 seconds, paying close attention to fingernails, and areas between the fingers.
- Rinse hands thoroughly with clean running water from a tap or a bucket.
- Dry hands with personal dry clean towel, paper towel or air dry (Using shared towel is not recommended as they quickly become contaminated).

¹ Natural or chemically treated and filtered water that is safe to drink and use for other purposes (handwashing and medical instrument cleaning). Clean water has zero level of microorganisms including bacteria, viruses and parasites, has low turbidity and has minimum level of disinfectants, disinfectant by-products and organic materials.

- If using personal towel, it should be washed every day.
- Use paper towel or towel used for drying hands when turning off water.

Note:

- If bar soap is used, provide small bars and soap racks, which drain.
- Use running water and avoid dipping hands into a basin containing standing water; even with addition of an antiseptic agent because microorganisms can survive and multiply in these solutions.
- A bucket with tap or a bucket with a pitcher can be used if running water is not available from the tap.
- If liquid soap is being used, do not add soap to partially empty liquid soap dispenser.
- Liquid soap dispenser should be washed and dried before refilling it.

Hand Antisepsis

The purpose of hand antisepsis is to remove soil and debris and reduce both transient and resident flora on the hands.

- The technique for hand antisepsis is similar to handwashing except that it involves use of soap containing an antimicrobial agent instead of plain soap or detergent.

Hand antisepsis should be done before:

- Examining or caring for highly susceptible patients (e.g., premature infants, elderly patients or those with advanced AIDS, etc.),
- Performing an invasive procedure such as placement of an intravascular device, and
- Leaving the room of patients on Contact Precautions (e.g., Hepatitis A or E), or who have drug resistant infections (e.g., Methicillin-resistant *S. aureus*).

Antiseptic Handrub

The purpose of antiseptic handrub is to inhibit or kill transient and resident flora. Use of a waterless, alcohol-based handrub product is more effective in killing transient and resident flora than antimicrobial handwashing agents or plain soap and water. Antiseptic handrub is quicker and easier to perform, and gives a greater initial reduction in hand flora. These handrubs also contain a small amount of an emollient such as glycerin, propylene glycol or sorbitol that protects and softens skin.

A nonirritating, antiseptic handrub can be made by adding either glycerine^a, propylene glycol or sorbitol to alcohol (2 mL in 100 mL of 60–90% ethyl or isopropyl alcohol solution) (Larson 1990; Pierce 1990). Use 5 mL (about one teaspoonful) for each application and continue rubbing the solution over the hands until they are dry (15–30 seconds).

^a Glycerine is often sold in cosmetic departments because it is used as a hand softener.

To be effective, an adequate amount (5 ml) of antiseptic handrub solution should be used. For appropriate handrub:

- Apply enough alcohol-based handrub to cover the entire surface of hands and fingers.
- Rub the solutions vigorously into hands, especially between the fingers and under the nails until dry.
- Do not rinse hands after applying handrub.

Since alcohol based handrubs do not remove soil or organic materials, if hands are visibly soiled or contaminated with blood or body fluids, handwashing with soap and water should be done first. In addition, to reduce the “build up” of emollients on hands after repeated use of alcohol-based handrubs, washing hands with soap and water every 5–10 applications is recommended.

Surgical Handscrub

The purpose of surgical handscrub is to remove soil, debris, transient organisms and to reduce resident flora prior to performing any surgical procedure and for the whole duration of the procedure. The goal is to prevent wound contamination by microorganisms from the hands and arms of the surgeon and assistants.

Appropriate surgical handscrub involve following steps:

1. Remove rings, watches and bracelets.
2. Thoroughly wash hands, especially between fingers, and forearms up to the elbows with soap and water.
3. Clean nails with a nail cleaner (tooth pick or any other pointed instrument).
4. Rinse thoroughly with clean, running water.
5. Apply an antiseptic agent (e.g., 2–4% chlorohexidine).
6. Vigorously rub all surfaces of hands, fingers and forearms for at least 2 minutes.
7. Rinse hands and arms thoroughly, holding hands higher than the elbows (If available, use cooled, filtered and boiled water).
8. Keep hands up and away from the body.
9. **Do not** touch any surface or article and dry hands and forearms with a clean, dry towel or air dry.
10. Put sterile or high-level disinfected surgical gloves on both hands.

Alternatively, handwashing with plain soap and water followed by use of a waterless, alcohol-based handrub containing chlorhexidine has been shown to yield significantly greater reduction in microbial counts on hands, improve skin health and reduce time and saves resources (Larson et al 2001).

The steps of performing this simpler and shorter surgical handscrub technique are:

- Remove rings, watches and bracelets.
- Thoroughly wash hands and forearms to the elbows with soap and water.
- Clean nails with a nail cleaner (tooth pick or any other pointed instrument).
- Rinse with clean running water and dry thoroughly with a clean, dry towel or air dry.
- Apply 5 ml of a waterless, alcohol-based handrub to hands, fingers, and forearms and rub until dry; repeat applications and rubbing 2 more times for a total of at least 2 minutes, using a total of about 15 ml of the handrub.
- Keep hands up and away from the body; do not touch any surface or article prior to putting sterile or high-level disinfected surgical gloves on both hands.

Remember: Even where there is no running water, hand washing is possible and is required.

If there is not running water, consider using a:

- A bucket with a tap
- A pitcher or a jug to pour water over hands with the help of an assistant
- Waterless alcohol-based solution

Drying Hands

Avoid using common towels. Shared towels may harbor microorganisms and contaminate hands even after proper handwashing or handrub.

- Use a waterless alcohol-based preparation.
- Air dry hands.
- Carry and use a small, personal towel that is replaced or cleaned daily or when wet or visibly soiled.

Other Considerations

- Follow the guidelines for using gloves with hand hygiene guidelines.
- To minimize contact dermatitis related to frequent handwashing (>30 times per shift) due to the use of harsh detergents and frequent exposures to antiseptic agents, healthcare workers may use hand lotions, creams and moisturizing skin care products. Such products can help prevent and treat contact dermatitis. Such products should be water based and without fragrance.

- Cuticles, hands, and forearms should be free from lesions (dermatitis or eczema) and skin breaks. Cuts and abrasions should be covered with waterproof dressings. If covering them in this way is not possible, surgical staff with skin lesions should not operate until the lesions are healed.
- Research has shown that the area around the base of nails contains the highest microbial count on the hand (McGinley, Larson and Leydon 1988). Several recent studies have shown that long nails may serve as a reservoir for gram-negative bacilli, yeast and other pathogens. Moreover, long nails, either natural or artificial, tend to puncture gloves more easily.

GUIDELINES FOR IMPROVING HANDWASHING COMPLIANCE BY THE STAFF

Though handwashing has been considered as one of the most important measures for reducing transmission of microorganisms and preventing infection for more than 150 years, compliance to handwashing has been a challenge faced by every healthcare facility.

Although it is difficult to change behavior of the staff towards handwashing, there are certain steps that increase the chances of success. These includes but are not limited to:

- Widely disseminating current guidelines for hand hygiene practices and the evidence supporting their effectiveness in preventing diseases and the need for health workers to adhere to the guidelines/practices.
- Involving hospital administrators in promoting and enforcing the guidelines by convincing them of the cost benefits of handwashing and other hand hygiene practices.
- Using successful educational methods including role modeling, mentoring, monitoring, and positive feedback.
- Using performance improvement approaches targeted to all healthcare staff, not just physicians and nurses, to promote compliance.
- Considering the needs of staff for convenient and effective options for hand hygiene that make compliance easier.
- Making available alternative options like waterless alcohol-based handrubs. This has shown to improve the compliance with the handwashing.

REFERENCES

Boyce JM and D Pittet. 2002. Guidelines for hand hygiene in healthcare settings: recommendations of the Healthcare Infection Control Practices Advisory Committee and the HICPAC/SHSA/APIC/IDSA Hand Hygiene Task Force. *Infect Control Hosp Epidemiol* 23(Suppl): S3–S40. Available at: <http://www.cdc.gov/handhygiene>

Centers for Disease Control and Prevention (CDC). 1989. Guidelines for prevention of transmission of human immunodeficiency virus and hepatitis virus to healthcare and public-safety workers. *MMWR* 38(S-6): 5–6.

Deshmukh N, JW Kramer and SI Kjellberg. 1996. A comparison of 5-minute povidone-iodine scrub and a 1-minute povidone-iodine scrub followed by alcohol foam. *Mil Med* 163(3): 145–147.

Kikuchi-Numagami K et al. 1999. Irritancy of scrubbing up for surgery with or without a brush. *Acta Derm Venereol* 79(3): 230–232.

Larson E et al. 2000. An organizational climate intervention associated with increased handwashing and decreased nosocomial infections. *Behav Med* 26(1): 14–22.

- Larson E et al. 2001. Comparison of different regimens for surgical hand preparation. *AORN J* 73(2): 412–432.
- Pereira LJ, GM Lee and KJ Wade. 1990. The effect of surgical handwashing routines on the microbial counts of operating room nurses. *Am J Infect Control* 18(6): 354–364.
- Pereira LJ, GM Lee and KJ Wade. 1997. An evaluation of five protocols for surgical handwashing in relation to skin condition and microbial counts. *J Hosp Infect* 36(1): 49–65.
- Pittet D et al. 2000. Effectiveness of a hospital-wide programme to improve compliance with hand hygiene. *Lancet* 356(9238): 1307–1312.

CHAPTER 3

GLOVES

Hand hygiene, coupled with the use of protective gloves, is a key component in minimizing the spread of disease and maintaining an infection-free environment. In addition, understanding when sterile or high-level disinfected gloves are required and, equally important, **when they are not**, can reduce costs while maintaining safety for both patients and staff.

TYPES OF GLOVES AVAILABLE IN ETHIOPIA

- Sterile or high-level disinfected surgical glove
- Clean Examination gloves
- Utility gloves

Wear gloves:

- When there is a reasonable chance of hands coming in contact with blood or other body fluids, mucous membranes or nonintact skin;
- Before performing invasive medical procedures (e.g., inserting vascular devices such as peripheral venous lines); or
- Before handling contaminated waste items or touch contaminated surfaces.

GENERAL PRINCIPLES FOR GLOVES USE

- All staff should wear appropriate gloves prior to contact with blood, body fluids, secretions or excretions from any client/patient.
- A separate pair of gloves must be used for each client to avoid cross-contamination.
- Wearing gloves does not replace the need for handwashing.

WHAT TYPE OF GLOVES TO USE

- **Disposable clean examination gloves** are preferred (High-level disinfected reusable gloves are acceptable) when there is contact with mucous membrane and nonintact skin (e.g., performing medical examinations and procedures such as pelvic examination).
- **Sterile surgical gloves** should be used when performing surgical procedures.
- **High-level disinfected surgical gloves** are the **only** acceptable alternative if sterile surgical gloves are not available, when performing surgical procedures.

- **Clean, heavy duty household (utility) gloves** should be used for cleaning instruments, equipment, contaminated surfaces, and while handling or disposing of contaminated waste. Double gloving using either new examination gloves or reprocessed surgical gloves provide some protection in case utility gloves are not available.

Table 3-1 provides guidelines on gloves use for common medical and surgical procedures.

Table 3-1. Glove Requirements for Common Medical and Surgical Procedures

TASK OR ACTIVITY	ARE GLOVES NEEDED?	PREFERRED GLOVES ^a	ACCEPTABLE GLOVES
Blood pressure check	No		
Temperature check	No		
Injection	No		
Blood drawing	Yes	Exam ^b	HLD Surgical ^d
IV insertion and removal	Yes	Exam ^b	HLD Surgical ^d
Pelvic examination (not for woman in labor)	Yes	Exam	HLD Surgical ^d
IUD insertion (loaded in sterile package and inserted using no-touch technique)	Yes	Exam	HLD Surgical ^d
IUD removal (using no-touch technique)	Yes	Exam	HLD Surgical ^d
Manual vacuum aspiration (using no-touch technique)	Yes	Exam	HLD Surgical ^d
Norplant implants insertion and removal	Yes	Sterile Surgical ^c	HLD Surgical ^d
Vaginal delivery	Yes	Sterile Surgical ^c	HLD Surgical ^d
Cesarean section or laparotomy	Yes	Sterile Surgical ^c	HLD Surgical ^d
Vasectomy or laparoscopy	Yes	Sterile Surgical ^c	HLD Surgical ^d
Handling and cleaning instruments	Yes	Utility	Exam or HLD Surgical ^d
Handling contaminated waste	Yes	Utility	Exam or HLD Surgical ^d
Cleaning blood or body fluid spills	Yes	Utility	Exam or HLD Surgical ^d

^a Although **sterile gloves** may be used for any surgical procedure, they are **not** always required. In some cases, examination or HLD surgical gloves are equally safe and less expensive.

^b This includes new, “never” used individual or bulk-packaged examination gloves (as long as boxes are stored properly).

^c When sterilization equipment (autoclave) is not available, high-level disinfection is the **only** acceptable alternative.

^d Reprocessed surgical gloves.

Adapted from: Tietjen, Cronin, and McIntosh 1992.

REMOVING AND DISCARDING OR REPROCESSING GLOVES

- If gloves are to be discarded, briefly immerse them in 0.5% chlorine solution, remove and dispose in a container for contaminated waste.
- If gloves are to be processed and reused, remove gloves by inverting them and soak the gloves in the 0.5% chlorine solution for 10 minutes before cleaning and processing them

WEARING GLOVES

General guidelines for wearing gloves are given in **Table 3-2**.

Table 3-2. Glove Wearing Guidelines

PROCEDURES	TYPE OF GLOVES	COMMENTS
Any time there may be contact with mucous membranes and broken or non-intact skin	<ol style="list-style-type: none"> 1. Examination gloves (recommended) 2. Sterilized or high-level disinfected surgical gloves (acceptable) 	<ol style="list-style-type: none"> 1. Single use disposable gloves 2. High-level disinfected reusable surgical gloves are acceptable if disposable examination gloves are not available
<p>All procedures involving contact with any tissue underneath the skin</p> <p>For example starting an IV line, handling contaminated waste or touching contaminated surfaces</p>	<ol style="list-style-type: none"> 1. Sterile surgical gloves (recommended) 2. Sterilized reusable surgical gloves (acceptable) 3. High-level disinfected reusable surgical gloves (acceptable only if there are no sterile gloves) 	<ol style="list-style-type: none"> 1. Single use disposable sterile surgical gloves 2. Sterilized reusable surgical gloves are acceptable if disposable sterile surgical gloves are not available 3. When sterilization equipment is not available, high-level disinfection is the only acceptable alternative
<p>Handling and cleaning used instruments</p> <p>Cleaning contaminated surfaces</p> <p>Handling or disposing or disposing or contaminated waste</p>	<ol style="list-style-type: none"> 1. Heavy duty household (utility) gloves (recommended) 2. Double gloving with reprocessed surgical or new examination gloves are acceptable 	<ol style="list-style-type: none"> 1. Heavy duty utility gloves: These are reusable, but must be decontaminated and cleaned between use 2. When utility gloves are not available, double gloving with reprocessed surgical gloves or new examination gloves provide some protection
<p>Gloves are not required if there is not contact with mucous membranes, blood, body fluids, secretions, or excretions (e.g., checking blood pressures, temperature check, or giving IM injections)</p> <p>Gloves should not be worn when it is not required, to ensure availability when needed (i.e., use sterile gloves for necessary purpose only—they are expensive irrespective of who is paying for it)</p>		NO GLOVES REQUIRED

When to Double Glove

- The procedure involves coming in contact with large amounts of blood or other body fluids.
- Orthopedic procedures in which sharps bone fragments, wire sutures and other sharps are likely to be encountered.
- Surgical gloves are reused.
- Surgical procedures lasting more than 30 minutes.

Whether or not the surgeon, assistant or nurse should double glove should be considered carefully, especially where gloves are reused and in areas where the risk of contracting blood borne pathogens, such as HIV, is high (>5% prevalence).

When to Use Elbow Length Gloves

Elbow length gloves should be used during vaginal deliveries and cesarean sections when the chance of coming in contact with blood is 25% and 35% respectively. Elbow length gloves are also recommended while performing procedures like manual removal of placenta and any other procedure where there is a contact with large volume of blood or body fluids.

When readymade elbow length gloves are not available, an effective alternative (as described below) can be easily made from previously used surgical latex gloves that have been decontaminated, cleaned and dried, and either sterilized or high-level disinfected.

1. Cut the four fingers completely off each glove just below where all the fingers join the gloves (see **Figure 3-1**).

Figure 3-1. Cutting the Four Fingers Off a Glove

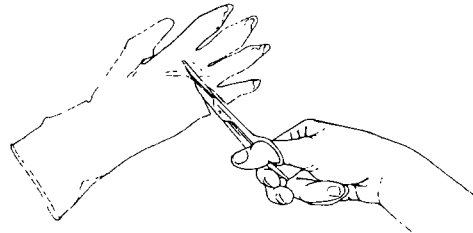

2. Sterilize or HLD 2–3 pairs of cut-off (fingerless) gloves according to the recommended process for each method and store the gloves after final processing in a sterile or high-level disinfected container until needed

How to Use

- Perform surgical handscrub.
- Put fingerless sterile or HLD gloves and pull up to the forearms.

- Put intact sterile or HLD surgical gloves on both hands so that the distal end of the fingerless gloves is completely covered (see **Figure 3-2**).

Figure 3-2. Putting Surgical Gloves on Both Hands

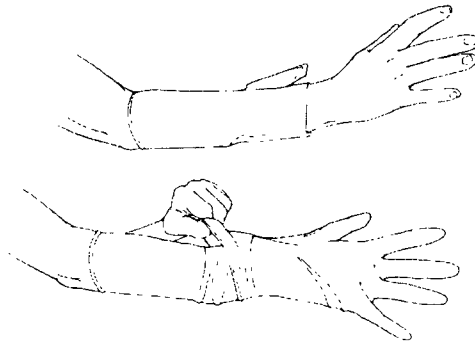

SOME DOS AND DON'TS ABOUT GLOVES

- **Do** wear the correct size gloves, particularly the surgical gloves. A poorly fitting glove can limit your ability to perform the task and may get damaged easily
- **Do** change surgical gloves periodically (every 45 minutes) during long cases as the protective effect of latex gloves decreases with time and inapparent tears may occur
- **Do** keep fingernails trimmed moderately short (less than 3 mm beyond the finger tip) to reduce the risk of tears
- **Do** pull gloves up over cuffs of gown (if worn) to protect the wrists
- **Do** use water-soluble hand lotions and moisturizers often to prevent hands from drying, and cracking due to frequent handwashing and gloving
- **Don't** use oil-based hand lotions or creams, because they will damage latex rubber surgical and examination gloves
- **Don't** use latex gloves if you have allergy to latex
- **Don't** store gloves in areas where there are extremes of temperature (e.g., direct sunlight, near the heater, air conditioner, ultraviolet light, and X-ray machine). These conditions may damage the gloves (cause breakdown of the material they are made of), thus reducing their effectiveness as a barrier
- **Don't** reprocess gloves that are cracked or have detectable holes/tears
- **Don't** reprocess examination gloves for reuse

REFERENCES

Centers for Disease Control (CDC). 1987. Recommendations for prevention of HIV transmission in healthcare settings. *MMWR* 36(Suppl 2): 1S–18S.

National Institute for Occupational Safety and Health, Department of Health and Human Services (NIOSH). 1997. *NIOSH Alert: Preventing Allergic Reaction to Nature Rubber Latex in the Workplace*. No. 97: 135.

CHAPTER 4

PERSONAL PROTECTIVE EQUIPMENT AND DRAPES

Protective barriers and clothing, now commonly referred to as personal protective equipment (PPE), have been used for many years to protect clients from microorganisms present on medical staff and others working in the healthcare setting. More recently, with the emergence of HIV/AIDS and HBV/HCV and resurgence of tuberculosis in many countries including Ethiopia, PPE now become important for protecting the healthcare providers as well.

Table 4-1 describes how personal protective equipment blocks the spread of microorganisms. This will help health workers and healthcare facility make decisions about using personal protective equipment.

PERSONAL PROTECTIVE EQUIPMENT

Table 4-1. How Personal Protective Equipment Blocks the Spread of Microorganisms

WHERE MICROORGANISMS ARE FOUND	HOW MICROORGANISMS ARE SPREAD	BARRIERS TO STOP THE SPREAD OF MICROORGANISMS	WHO THE BARRERS PROTECTS
Healthcare Staff			
Hair and scalp	Shedding skin or hair	Cap	Patient
Nose and mouth	Coughing, talking	Mask (water resistant)	Patient
Body and skin	Shedding skin or hair	Scrubsuit, covergowns	Patient
Hands	Touching	Gloves, handwashing or waterless antiseptic	Patient
Patient			
Mucous membranes and nonintact skin	Touching	Gloves	Patient and staff
Blood and body fluids	Splashing or spraying	Gloves, eyewear, mask, drapes, and apron	Staff
	Touching (contact)	Instrument processing	Patient
	Accidental exposure with contaminated needles and scalpel blades	Protective footwear, decontamination and disposal; use of a Safe or Neutral Zone during surgery	Staff
	Infectious waste	Utility gloves, plastic bags and proper disposal	Staff
Unprepared skin	Touching	Skin preparation, drapes, gloves	Patient
Clinic or hospital environment	Touching	Gloves, handwashing Dressing	Staff and their families

Table 4-2. Types of Personal Protective Equipment

TYPE OF PPE	MUST BE USED FOR	PRIMARILY PROTECTS
Caps, Gowns/Scrub Suits, Masks, Aprons, Drapes	Invasive procedures where tissue beneath the skin is exposed	Service provider and client
Closed boots or shoes (open sandals are not acceptable)	Situation involving sharp instruments or where spillage or infectious agents is likely	Service provider
Goggles or glasses, Masks, Apron, or Mackintosh	Situation where splashing or blood, body fluids, secretions or excretions is likely	Service provider
Mackintosh or Apron	Situation where splashing or spillage of blood, body fluids, secretions or excretions is likely	Service provider
Masks	Situation which call for airborne or droplet transmission precautions	Service providers and client
Sterile Drapes	Major or minor surgical procedures	Client

Caps are used to keep the hair and scalp covered so that flakes of skin and hair are not shed into the wound during surgery. Caps should be large enough to cover **all** hair.

Eyewear protects staff in the event of an accidental splash of blood or other body fluid by covering the eyes. Eyewear includes clear plastic goggles, safety goggles, and face shields. Prescription glasses are also acceptable. Masks and eyewear should be worn when performing any task where an accidental splash into the face could occur. If faceshields are not available, goggles or glasses and mask can be used together.

Footwear is worn to protect feet from injury by sharp or heavy items or fluids that may accidentally fall or drip on them. For this reason, sandals, “thongs” or shoes made of soft materials are not acceptable. Rubber boots or leather shoes are acceptable, but they must be kept clean and free of contamination from blood or other body fluid spills. Shoe covers are unnecessary if clean, sturdy shoes are available for **dedicated use only in the surgical area**.

Gloves protect hands from infectious materials and protect patients from microorganism on staff members’ hands. They must be worn anytime there is a possibility of contact with potentially infectious materials or when handling contaminated waste or cleaning or disinfecting instruments. Gloves should be changed between each client contact to avoid cross contamination. Gloves should not be worn for non-critical procedures such as bed making, however, handling visibly soiled linen requires utility gloves.

Mackintosh or plastic apron is used to protect clothing or surfaces from contamination. Aprons made of rubber or plastic provide a waterproof barrier along the front of the healthcare worker’s body and should also be worn during procedures where there is a likelihood of splashes or spillage of blood, body fluids, secretions or excretions (e.g., when conducting deliveries).

Masks should be large enough to cover nose, lower face, jaw and all facial hair. They are worn in an attempt to contain moisture droplets expelled as health workers or surgical staff speak, cough or sneeze, as well as to prevent accidental splashes of blood or other contaminated body fluids from entering the health workers’ nose or mouth. Unless the masks are made of fluid-resistant materials, however, they are not effective in preventing either very well.

Scrubsuits or covergowns are worn over, or instead of, routine clothes. A V-neck shirt must not be cut so low as to slide off the wearers' shoulders or expose men's chest hair.

Surgical gowns were first used to protect patients from microorganisms present on the abdomen and arms of the healthcare staff during surgery. Lightweight cloth gowns, generally available in Ethiopia, however, offer little protection. Under the circumstances, either wear a plastic apron before putting on the surgical gowns or, if large spills occur, take shower or bathe as soon as possible after completing the surgery or the procedure.

Drapes

There are four types of drapes: towel drapes, drapes or lap sheets, site drapes, and pack wrapper drapes.

Sterile drapes made of cloth can be placed around a prepared surgical incision to create a work area. Cloth drapes allow moisture to soak through and can help to spread organisms from skin, even after surgical cleansing with an antiseptic agent, into the incision. Thus, neither gloved hands nor sterile or high-level disinfected instruments and other items should touch drapes once they are in place. Using towel drapes to create a work area around the incision limits the amount of skin that needs to be cleaned and it reminds the surgical team not to touch the other areas.

USING DRAPES FOR SURGICAL PROCEDURE

- All drapes should be applied around a completely dry, widely prepared skin.
- If sterile drapes are used, sterile or HLD surgical gloves should be worn when placing the drapes.
- Drapes should be handled as little as possible and should never be shaken or flapped.
- Always hold drapes above the area to be draped, and discard the drape if it falls below this area

For minor surgical procedure:

- Use a site drape if the open skin required around the incision is not bigger than five cm.
- Place the hole in the drape over the prepped incision site and do not move it once it has touched the skin.
- If site being draped is not sterile, put on a sterile or HLD gloves after placing the drape on the patient to avoid contaminating the gloves.

For major surgical procedure:

- Use large drapes or lapsheets to cover patient's body. These drapes do not need to be sterile because they will not be near the incision site. They should be clean and dry.
- After preparing the skin place the sterile towel drapes to square off the incision site.

- Begin by placing the drape on the area closest to you. Once in place, the drape should never be moved closer to the incision. It can, however, be pulled away from it.
- Use non-perforating towel clips to secure the corners of the towel drapes.

During Procedure

- Do not use the patient's body or the draped area for placing instruments.
- Keep all instruments on the instrument stand covered with a sterile towel or drape.

Remember: Once a sterile drape touches the patient's skin it is no longer sterile.

REFERENCES

- Chen CC and K Welleke. 1992. Aerosol penetration through surgical masks. *Am J Infect Control* 20(4): 177–184.
- Gershon R and B Zirkin. 1995. Behavioral factors in safety training, in *Laboratory Safety, Principles and Practices*, 2nd ed. Fleming DO et al (eds). AMS Press: Washington, DC, pp 269–277.
- Gershon R and D Vlahov. 1992. Assessing and reducing HIV risk to the critical care nurse. *Critical Care Nursing Currents* 3: (No 3).
- Larson EL et al. 1995. APIC Guidelines for Infection Control Practice. Guidelines for handwashing and hand antisepsis in healthcare settings. *Am J Infect Control* 23(4): 251–269.
- Mitchell NJ. 1991. Surgical facemasks in modern operating rooms—a costly and unnecessary ritual? *J Hosp Infect* 18(3): 239–242.

CHAPTER 5

SURGICAL ANTISEPSIS

Postoperative wound infection remains a leading cause of nosocomial infections, especially in developing countries including Ethiopia. A vast majority of postoperative incisional or superficial wound infections are caused by microorganisms normally found on the patient's skin or from mucous membranes adjacent to the surgical site, and less often from other sites and surgeon or the assistants.

Preoperative surgical antiseptics consists of three processes:

- Hand hygiene
- Gloving of the surgical team
- Applying antiseptic agent to the surgical site

Handhygiene and use of gloves has been discussed earlier. This chapter will focus on preparing skin and mucous membrane prior to procedures.

Although skin cannot be sterilized, applying an antiseptic solution minimizes the number of microorganisms around the surgical site that may contaminate the surgical wound and cause infection.

GENERAL PRINCIPLES

- If visibly soiled, clean any injection site, operative site, or external genitalia with soap and water before applying any antiseptic.
- No skin preparation is required prior to giving intramuscular, subcutaneous or intradermal injections unless the injection site is visibly soiled.
- Surgical sites should be prepared with an appropriate antiseptic solutions, using a circular motion starting from the center and working outward.
- The vagina and cervix should be prepared using a speculum by applying an appropriate antiseptic solution 2–3 times prior to inserting anything into the cervical os.
- Never use alcohol containing antiseptic to prepare mucous membrane (e.g., vagina and cervix)
- Always allow the antiseptic enough time to dry.
- **Do not** allow the antiseptic to pool underneath the patient's body; this can irritate the skin.
- **Do not** shave surgical sites as shaving increases the likelihood of infection.
- **Do not** remove hair from surgical sites at all unless absolutely necessary. If hair must be removed, trim the hair close to the skin surface immediately before surgery, being careful not to nick or injure the skin.
- Always ask patient about allergic reactions before selecting an antiseptic solution.

Select an antiseptic solution from the following recommended products:

- Alcohol based solutions of iodine and chlorhexidine
- Alcohols (60–90% ethyl, isopropyl or “methylated spirits”)
- Chlorhexidine gluconate (2–4%)
- Chlorhexidine gluconate and cetrimide, various concentration at least 2% (e.g., Savlon®)
- Iodine (3%) aqueous iodine and alcohol containing products
- Iodophors (7.5–10%), various other concentrations (e.g., Betadine)
- Chloroxylenol (Para-chloro-metaxyleneol or PCMX) (0.5–3.75%), various other concentrations (e.g., Dettol®)

DO NOT dilute Savlon® or Dettol® available in the market.

Product that should not be used as antiseptic:

- Hexachlorophene
- Benzalkonium Chloride
- Mercury Laurel or other Mercury Containing Compounds

STORING AND DISPENSING ANTISEPTIC

- Pour the antiseptic into a small, reusable container for daily use
- Label the container correctly
- **Do not** store gauze or cotton wool in antiseptic because this promotes contamination
- **Do not** refill antiseptic dispenser before washing and cleaning once it is near empty or empty.
- Wash reusable antiseptic containers thoroughly with soap and clean water, rinse with boiled water if available and drip dry before refilling
- Label reusable antiseptic containers with the date each time they are washed, dried and refilled
- Concentrated antiseptic solutions should be stored in a cool, dark area. Never store them in direct sunlight or in excessive heat.

Always follow the manufacturer’s instructions for diluting an antiseptic solution.

Table 5-1. Antiseptic Solutions: Microbiologic Activities and Potential Uses

GROUP	ACTIVITY AGAINST BACTERIA						RELATIVE SPEED OF ACTION	AFFECTED BY ORGANIC MATTER	USES		Comments
	Gram Pos.	Most Gram Neg.	TB	Virus	Fungi	Endo spores			Surgical Scrub	Skin Prep	
Alcohols (60–90% ethyl or isopropyl)	Good	Good	Good	Good	Good	None	Fast	Moderate	Yes	Yes	Not for use on mucous membranes; not good for physical cleaning of skin, no persistent activity
Chlorhexidine ¹ (2–4%) (Hibitane, Hibiscrub)	Good	Good	Fair	Good	Fair	None	Intermediate	Slight	Yes	Yes	Has good persistent effect; Toxicity to ears and eyes
Iodine Preparation (3%) (Water or alcohol based)	Good	Good	Good	Good	Good	Poor	Fast	Marked	No	Yes	Not for use on mucous membranes or open wounds; Can burn skin so remove after several minutes
Iodophors (7.5–10%) (Betadine [®])	Good	Good	Good	Good	Good	None	Intermediate	Moderate	Yes	Yes	Can be used on mucous membranes. Wait for 2 minutes after applying
Para-chloro-metaxynelol (PCMX) (0.5–4%)	Fair	Good	Poor	Fair	Poor	Unknown	Slow	Minimal	No	Yes	Penetrates the skin and should not be used on newborns
Triclosan (0.2–2%)	Good	Good	Fair	Good	Poor	Unknown	Intermediate	Minimal	Yes	No	Acceptability on hands varies

¹ Note: Savlon[®], which contains chlorhexidine, is not listed because concentration of chlorhexidine vary from country to country from less than 1% to 4%. Some of these agents, such as iodine or chlorhexidine, are combined with alcohol to form tinctures and are available in the combined formulations.
Adapted from: Larson 1988; Olmsted 1996.

REFERENCES

Hutin Y et al. 2001. Best infection control practices for intradermal, subcutaneous and intramuscular needle injections. World Health Organization (WHO), Safe Injection Global Network: Geneva.

Nichols RL. 1991. Surgical wound infection. *Am J Med* 91(Suppl 3B): 54S–64S.

Spaulding EH (ed). 1968. Chemical disinfection of medical and surgical materials, in *Disinfection, Sterilization and Preservation*. Lawrence CA et al (eds). Lea & Febiger: Philadelphia, pp 437–446.

SAFE PRACTICES IN THE OPERATING ROOM

The operating room has special characteristics that increase the chance of accidents. The staff often uses and passes sharp instruments without looking at the instrument or letting the other person know what they are doing. The workspace is confined and ability to see what is going on in the operative field for some members of the team may be poor. There is moreover, the need for speed and the added stress of anxiety, fatigue, frustration and even anger. Finally, in many instances the exposure to blood often occurs without the person's knowledge, usually not until the gloves are removed. The fact that fingers are frequently the site of minor scratches and cuts further increases the risk of infection with blood borne pathogens.

To avoid all injuries that could result from handling sharp instruments and objects (e.g., hypodermic needles, wire sutures, skin hooks and towel clips, sharp-toothed tenaculi and scalpel blades):

- Use a small Mayo forceps (**not fingers**) when holding the scalpel blade, putting it on or taking it off or loading the suture needle.
- Always use tissue forceps (**not fingers**) to hold tissue when using a scalpel or suturing.
- Use a "hands free" technique to pass or transfer sharps by establishing a Safe or Neutral Zone in the operative field.
- Always remove sharps from the field immediately after use and put in a sharp container.
- Make sure that sharps containers are replaced when they are only three-quarters full and place containers as close and conveniently as possible to where sharps are being used.

THE "HANDS FREE" TECHNIQUE FOR PASSING SURGICAL INSTRUMENTS

1. Place a sterile or high-level disinfected kidney basin, or other suitable small container, on the operative field between assistants and the surgeon. The container is designated as the Safe or Neutral Zone in which sharps are placed before and immediately after use.
2. Alert the surgeon when a sharp instrument is being transferred. Say "sharp" and then pass the instrument.
3. To avoid dulling scalpel blades, use a plastic container or place a sterile cloth in a metal container.

DESIGNING SAFER OPERATIONS

- Have a brief preoperative discussion of how sharps will be handled during the procedures by all team members and needs of the surgeon during surgery.
- Review how to make each step in the operation safe.

- Avoid using straight suture needles; use curved needles instead.
- If available, use blunt needles for suturing soft tissues.

Post Exposure Prophylaxis Guidelines

The Disease Prevention and Control Department of the Ministry of Health in collaboration with HIV/AIDS Prevention and Control Office (HAPCO) and Drug Administration and Control Authority published the Guidelines for Use of Antiretroviral Drugs in Ethiopia, in 2003. According to these guidelines proper infection prevention practices, which include appropriate following of standards precautions, is the most effective way of protecting healthcare providers from accidental transmission of HIV and other blood borne pathogens. The priority, therefore, must be to train all healthcare personnel in prevention methods and to provide them with necessary safe materials and personal protective equipment.

Components of post-exposure management include crisis management, risk assessment, laboratory assessment of source, post-exposure prophylaxis, and followup care.

Testing

Testing source: Rapid test is done, following the national testing protocol, after pretest counseling and consent has been given by the source. Posttest counseling is provided once the results are available.

Testing healthcare provider: HIV serology should be performed at the time of injury, and repeated at 6 weeks, 3 months, and 6 months. The healthcare worker should be advised to practice safe sex or abstain until serology is negative at 6 months post exposure.

WHO classification and indications for PEP is recommended for Ethiopia. This classification assumes that serological status of the source patient is known.

Table 6-1. Classification and Indications for PEP

TYPE OF EXPOSURE	SOURCE PATIENT HIV POSITIVE	
	Symptomatic and/or high viral load	Asymptomatic and/or low viral load
Massive	Recommended	Recommended
Intermediate	Recommended	Possible
Minimal	Possible	Possible (but to be discussed)

Timing of initiation of treatment: To be effective the time of administering the prophylaxis should be as short as possible (within 1–2 hours, post exposure). However, the maximum delay in initiation of treatment, which would block infection, is not known in humans. Prophylaxis is sometimes given empirically up to 2 weeks in the case of severe exposure when the delay has been unavoidable.

Therapeutic regimen: The therapeutic regimen may be decided on, drugs previously taken by the source patient, known or possible cross resistance of drugs taken by the source patient, seriousness of the exposure and availability of the various ARVs.

The use of ZDV, as monotherapy for PEP, no longer appears justified in countries where it has been used in patients for 10 years. Therefore, ZDV monotherapy for PEP is valid option in developing countries where ARVs are not available widely.

Post-HIV Exposure Prophylaxis

Table 6-2. Risk Categories and ARV Prophylaxis

RISK CATEGORY	ARV PROPHYLAXIS	DURATION
Low Risk	ZDV 300 mg bid + 3TC 150 mg bid OR Combivir 1 tab bid	28 days
High Risk	ZDV 300 mg bid + 3TC 150 mg bid + IDV 800 mg tid OR Combivir 1 tab bid + IDV 800 mg tid	28 days

Low risk exposure:

- Exposure to a small volume of blood or blood contaminated fluids from asymptomatic HIV positive patients
- Following an injury with a solid needle
- Any superficial injury or mucocutaneous exposure

High-risk exposure:

- Exposure to a large volume of blood or potentially infectious fluids or blood contaminated fluid from a patient with clinical AIDS or early seroconversion phase of HIV
- Injury with a hollow needle and/or deep and extensive injuries

When source virus likely to be resistant to or healthcare provider is intolerant of basic regimen, ddI 200 mg bid + d4T 40 mg bid, d4T 40 mg bid + 3TC 150 mg bid, ZDV 300 mg bid + ddI 200 mg bid. For high-risk exposure to HIV positive source or when source virus is resistant, basic regimen plus Protease Inhibitor, Dual PI, NNRTI or third NRTI (Abacavir) may be added. As the risk of transmission is low and there is no evidence that 3-drugs regimen is better than 2-drug regimen. 3-drug regimen is associated with more toxicity and decreased adherence.

Essential Steps to Follow When Post-Exposure Prophylaxis is Available

- **Identification of the accident:** The accidental exposure to blood must be recognized as such by the health worker. This requires training of all healthcare providers at risk.
- **Foresee/prepare arrangements:** These should function 24 hours a day. Anyone exposed should be able to receive confidential counseling and treatment in the hours following the accident.
- **Identify resource persons** among the health facility personnel to help the exposed person to take the necessary steps and take care of him/her.
- **Identify a prescriber** to evaluate the risk, decide on treatment to be offered and follow up the patient.

- **Initial serology:** The healthcare worker who has been accidentally exposed should have HIV pretest counseling and a reference serology within eight days of the accident to check for prior infection. All those initially testing negative should have follow up serology.
- **Serological followup:** counseling and testing should be offered at three and six months after the accident.
- **Provision of treatment:** The treatment, which will comprise of 1 or a combination of 2 to 3 ARVs must be available at all times, must not be out of stock or out of date and must be prescribed by a professional.

Serology testing of the source patient: when the serological status of the source patient is not known, this person must be informed about the accident in order to obtain consent to test for HIV. Confidentiality of the result must be maintained at all times. If he/she refuses to test for HIV or consent is not possible, prophylaxis should be considered if there are indications of possible infection.

REFERENCES

- Davis MS. 2001a. Advanced Precautions for Today's OR: The Operating Room Professional's Handbook for the Prevention of Sharps Injuries and Bloodborne Exposures, 2nd ed. Sweinbinder Publications LLC: Atlanta.
- Fox V. 1992. Passing surgical instruments, sharps without injury. AORN J 55(1): 264.
- Guidelines for Use of Antiretroviral Drugs in Ethiopia, Ministry of Health, Disease Prevention and Control Department in Collaboration with HIV/AIDS Prevention and Control Office (HAPCO) and Drug Administration and Control Authority (DACA) Addis Ababa, Feb. 2003.

SAFE AND APPROPRIATE USE OF INJECTIONS

The World Health Organization (WHO) estimates that at least 50 percent of all injections are unsafe—posing serious health risks to recipients, health workers, and the public. In many developing countries injection overuse and unsafe practices account for a substantial proportion of new infections with Hepatitis B Virus (HBV), Hepatitis C Virus (HCV) and Human Immunodeficiency Viruses (HIV). In the year 2000 only, WHO has estimated, injections with contaminated needles or syringes caused: 21 million new infections with hepatitis B, two million with hepatitis C and 260,000 new infection of HIV. Hence, eliminating unnecessary injections is the highest priority to prevent injection-associated infections. When injections are medically indicated they should be administered safely. Best injection practices for intradermal, subcutaneous or intramuscular injections include: the use of sterile injection equipment, the prevention of contamination of injection equipment and medication, the prevention of needle-stick injuries to the provider and the prevention of access to used needles to the community.

WHAT IS SAFE INJECTION?

A safe injection is an injection practice that does not harm the recipient, does not expose the provider to any avoidable risk, and does not result in any waste that is dangerous for other people.

BEST PRACTICES WHILE USING NEEDLES AND SYRINGES

These best practices are measures that have been determined through scientific evidences or expert consensus to most effectively protect patients, providers and communities. These are divided in to four major areas of intervention:

1. Use Sterile Injection Equipment

- Use a single use syringe and needle for each injection (Auto-disable syringes are mandatory for all immunization injections. For curative and other types of injection, syringes with reuse prevention devices and syringes with safety features are recommended. Where these are not available, standard disposable syringes can be used.)
- Ensure that the syringe and needle are sealed and inspect packaging for breaches in barrier integrity.
- If single use syringes and needles are unavailable, use equipment designed for steam sterilization. The quality of sterilization process must be confirmed using time, steam, temperature (TST) spot indicators.
- Reconstitute each unit of medication separately using single use syringe and needle or sterile equipment.

2. Prevent Contamination of Injection Equipment and Medication

- Prepare each injection in a clean designated area, where blood or body fluid contamination is unlikely.
- Use single dose vials rather than multi-dose vials.
- If multi-dose vials must be used, always pierce the septum with a sterile needle. Avoid leaving the needle in place in the stopper of the vial.
- Select pop-open ampoules rather than ampoules that require use of a metal file to open.
- If you are using an ampoule that requires a metal file to open, protect fingers with a clean barrier (e.g., small gauze pad) when opening the ampoule.
- Inspect for and discard medications with visible contamination or breaches of integrity (e.g., cracks, leaks).
- Follow product-specific recommendation for use, storage and handling.
- Swabbing of a new vial tops or ampoules with an antiseptic or disinfect is unnecessary. If swabbing with an antiseptic is selected for use, use a clean, single use swab and maintain product specific recommendation contact time. Do not use cotton balls stored wet in a multi-use container.
- Skin preparation before injection. Wash skin that is visibly soiled or dirty with soap and water. If swabbing with an antiseptic is selected for use, use a clean, single use swab and maintain product specific recommendation contact time. Do not use cotton balls stored wet in a multi-use container.
- Discard a needle that has touched any non-sterile surface.

3. Prevent Injuries to the Provider

Before administering an injection or any skin piercing procedure ensure that the following precautions are observed depending on the types of procedure being done.

- Anticipate and take measures to prevent sudden patient movement during and after injection.
- Avoid recapping and other hand manipulation of needles. *If recapping is necessary, use a single-handed scoop technique.*
- All used syringes and needles or any other sharps should be discarded at the point of use in an enclosed sharps container that is puncture and leak proof and that is sealed before completely full.
- Disposable gloves are indicated only if excessive bleeding anticipated.

3. Prevent Access to Used Needles and Syringes

- Seal sharp containers for transport to a secure area in preparation for disposal. After closing and sealing sharps containers, never open, empty or reuse or sell them.
- Manage/dispose sharps waste in an efficient, safe and environment-friendly way to protect people from voluntary or accidental exposure to used injection equipment.

SHARP CONTAINERS DO'S AND DON'TS

- **Do** put sharps containers as close to the point of use as possible and practical, ideally within arm's reach. Also, they should be easy to see, recognize and use.
- **Do** attach containers to walls or other surfaces if at all possible.
- **Do** mark them clearly so that people will not unknowingly use them as a garbage container or for discarding other items.
- **Do** place them at a convenient height so staff can use and replace them easily.
- **Do** mark the fill line at the three quarters full level.
- **Don't** shake a container to settle its contents and make room for more sharps.
- **Don't** place containers in high traffic areas (corridors outside patient rooms or procedure rooms) where people could bump into them or be stuck by someone carrying sharps to be disposed of.
- **Don't** place containers on the floor or anywhere they could be knocked over or easily reached by a child.
- **Don't** place containers near light switches, overhead fans or thermostat controls where people might accidentally put their hand into them.

PREPARING SHARPS FROM LOCALLY AVAILABLE MATERIALS

Several infection preventions programs in developing countries use locally available materials to prepare, simple, effective, and inexpensive sharp containers. The health workers and program managers are encouraged to use innovative approaches to develop sharps containers from readily available "throw away" items, such as metal food containers made of aluminum, tin or heavy plastics (e.g. cooking oil bottles and cans), heavy-duty cardboard boxes and even the used plastic drinking water bottles with caps. Although some are safer than other, they all provide a no-cost, sustainable source of disposable sharps container for use in small clinics, polyclinics and district-level hospitals with limited budgets.

Remember:

- Use those objects which are puncture resistant
- Identify where to put a hole on the container for dropping the used sharps
- Clearly name the container, "SHARPS"
- Mark a $\frac{3}{4}$ level line.
- Appropriately seal and dispose of container as per the waste disposal guidelines.

STANDARDS FOR ADMINISTERING INJECTIONS

- Prepare a well-laid up tray, include emergency drugs for management of possible drug reaction.
- Wash hands with soap and water. Alcohol could be used as a secondary step after soap and water except for EPI injections.
- Drip dry. You can use small paper towels or any single use towels.

- Check for the integrity of the vial/ampoule for the following: expiry dates, breach, leaks, particles or any contamination.
- Make sure that the right drug, right dose and route are used for the right patient or client.
- For medications that need to be reconstituted (powder forms) it should be done according to the manufacturer's instruction, using the correct diluents.
- Draw the right dose as prescribed, including expelling the air
- Ensure aseptic technique while giving the injection
- Administer the drug at the correct site
- Dispose the used syringes and needles immediately into the sharp's container. (Never give used syringes and needles to patients or clients to carry home even if they came with the equipment).
- A patient should be kept for at least 5 minutes after the injection has been given and be observed for any possible adverse effects or events.
- Thank the patient or the client.
- Record the date and time of injection administered.

Special Note:

- All patients undergoing an injection should be educated/counseled before injection is given e.g., type of drug, side effects, possible adverse effects/events following the administration of the injection and total number of doses to be given by injection.
- Self-injecting patients such as diabetic patients should be properly informed about their medications and how to ensure safety of injection. In case a patient needs to take the injection equipment home, he should be counseled on storage, disposal and sterility of their drugs and equipment.

REFERENCES

Simonsen L et al. 1999. Unsafe Injections in the developing world and transmission of blood borne pathogens: A review. *Bulletin World Health Organization* 77(10): 789–800.

WHO/BCT/03.01: Managing Injection Safety, 14 March 2003.

CHAPTER 8

WASTE MANAGEMENT

The purpose of waste management is to:

- Protect people who handle waste items from accidental injury,
- Prevent the spread of infection to healthcare workers who handle the waste,
- Prevent the spread of infection to the local community, and
- Safely dispose of hazardous materials.

Waste must be properly handled within the clinic setting, even before it is taken for incineration, burial or other disposal, to protect clients, staff, and the community.

Waste from healthcare facilities may be non-contaminated or contaminated (studies in other countries have shown that approximately 85% of the waste generated in the hospitals is non-contaminated)

Non-contaminated wastes pose no infectious risk to persons who handle them. Examples of non-contaminated waste include paper, trash, boxes, bottles and plastic containers, which contain products delivered to the clinic.

Contaminated waste potentially infectious or toxic, if not disposed of properly. Contaminated waste include, blood, body fluids, secretions and excretions and items that have come in contact with them, such as sharps and used dressings, as well as medicines, medical supplies or other chemicals that may be toxic.

- Contaminated and non-contaminated wastes should be separated at origin, to reduce the volume of contaminated waste and minimize the cost to the institution for more expensive procedures required for managing and disposing of contaminated waste properly.
- When possible, use separate containers for combustible and non-combustible waste.
- Never sort through contaminated wastes (e.g., do not try to separate non-contaminated waste from contaminated wastes, or combustible from non-combustible, after they have been combined).

STEPS OF WASTE MANAGEMENT

- Segregation
- Collection
- Transportation
- Disposal

How to Dispose of Sharps and Sharp Containers

- Use puncture-resistant sharps containers and work practices that minimize the unnecessary handling of sharps.
- When container is three-quarter full, remove from the procedure area for disposal.
- Dispose of the sharps and sharp containers by burning, burying or encapsulating.
- Always put on a heavy duty gloves when handling sharps containers.

Encapsulation is recommended as one of the alternative way to safely dispose of sharps, when burning or burying is not possible. For encapsulation sharps are collected in puncture-resistant and leakproof containers. When container is three-quarter full, a material such as cement, plastic foam or clay is poured into the container until completely filled. After the material has hardened, the container is sealed and buried. It is possible to encapsulate chemicals or pharmaceutical waste together with sharps.

How to Dispose of Liquid Waste

Liquid contaminated waste requires special handling, because it may pose an infectious risk to healthcare worker who handle the waste.

- Wear PPE including utility gloves, protective eyewear and plastic apron when handling and transporting liquid waste.
- Pour waste down a utility sink drain or a flushable toilet and rinse with water. Avoid splashing.
- If no sewage system available, dispose of liquid in a deep, covered hole, not into open drains.
- Decontaminate containers by placing them in a 0.5% chlorine solution before washing them.
- Remove utility gloves, wash and dry hands or use antiseptic handrub as described in the guidelines.

How to Dispose of Solid Waste

Dispose of contaminated wastes separately from non-contaminated waste, because contaminated wastes needs special handling as follows:

- Wear heavy duty or utility gloves when handling and transporting solid wastes.
- Dispose of solid wastes by placing them in a plastic or galvanized metal container with a tight fitting cover.
- Collect the waste containers on a regular basis and transport the burnable ones to the incinerator or area for burning.
- Remove gloves and wash and dry hands or use an antiseptic handrub.

Contaminated wastes should be disposed of during or immediately following a procedure, using non-corrosive leakproof containers with lids. There should be a sufficient number of waste containers, in convenient locations, to minimize carrying contaminated wastes from place to place.

Non-contaminated wastes should be managed at health facility level or through municipal disposal system.

How to Dispose of Hazardous Waste

All hazardous waste material—chemical, pharmaceutical and one containing heavy metals—should be incinerated or buried if the quantity is very small. The large quantity of such materials should be sent back to the original supplier.

Special situations

- If a patient or family member wants to take home the placenta or body parts for burial, first place them in a plastic bag and then into a rigid container for transport.
- Blood and other cultures and stocks of infectious agents from laboratory work should be sterilized by steam sterilization at the earliest, prior to disposal, if possible.

Final Disposal of Wastes

Open site of waste should be avoided because they:

- Pose infection risks and fire hazards
- Produce foul odor
- Attract insects
- Are unsightly

Incineration is controlled burning of solid, liquid or gaseous combustible wastes to produce gases and residues containing little or no burnable material.

- Incineration provides high temperatures and destroys microorganisms; and therefore, is the best method for disposal of contaminated wastes; incineration also reduces the bulk of wastes to be buried.
- Simple incinerators can be built from locally-available materials—bricks, concrete blocks, used fuel or oil drums, etc. as shown in **Figure 8-1**.
- Pressurized gas containers (aerosol cans), large amounts of reactive chemical waste, silver salts and photographic or radiographic wastes, plastic containing polyvinyl chloride (blood bags, IV sets or disposable syringes), and waste with high mercury or cadmium content, such as broken thermometers, used batteries and lead-lined wooden panels should not be incinerated.

Figure 8-1. Simple Incinerator using Local Materials

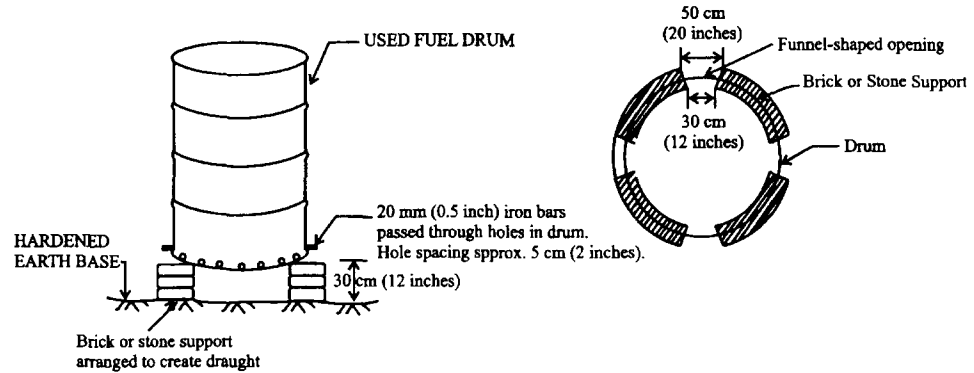

Figure 8-2. Stationary Incinerator



Source: Juncker et al 1994.

Burial

Only contaminated and hazardous waste needs to be buried. For effective and safe burial:

- Access to the disposal site should be restricted.
- The burial site should be lined with a material of low permeability, if possible.
- Select site at least 50 meters away from any water source to prevent contamination of the water table.
- The site should have proper drainage, be located downhill from any wells, free of standing water and not in an area that floods.

How to Make and Use a Small Burial Site for Waste Disposal

- Find an appropriate location as mentioned above.
- Dig a pit 1 meter square and 2 meter deep. The bottom of the pit should be 2 meters above water level.
- Dispose of the contaminated waste in the pit and cover the waste with 10–15 cm of soil each day. The final layer of dirt should be 50–60 cm and compacted to prevent odors and attractions of insects, and to keep animals from digging up the buried waste.
- Depending on volume such a pit should last for 30–60 days.

Figure 8-3. Burial Site for Waste Disposal

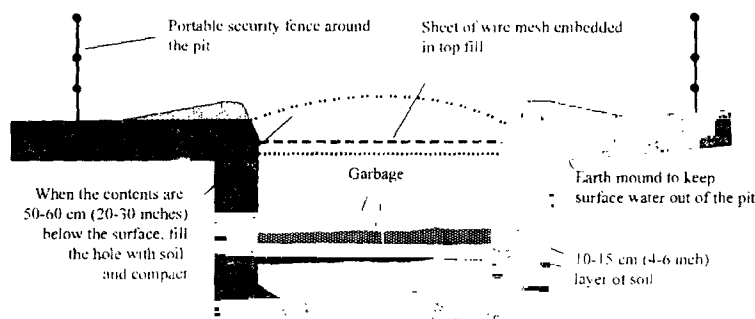

Waste Disposal Tips

- Use heavy duty utility gloves and appropriate personal protective equipment when handling wastes.
- Decontaminate and clean gloves between use.
- Handle wastes carefully to avoid spills or splashes.
- Always wash hands after removing gloves and handling contaminated wastes.
- Avoid transferring contaminated waste from one container to another.
- Incineration is the preferred method for waste disposal, as the heat will generally be sufficient to destroy infectious microorganisms and will also prevent scavenging and reuse of discarded items.
- If incineration is not possible, then careful burial is the next best alternative.
- Dispose of used toxic chemicals or medicine containers properly:
 - Rinse glass containers thoroughly with water; glass containers may be washed with detergent, rinsed, dried and reused
 - For plastic containers that contained toxic substances such as glutaraldehyde, rinse three times with water and dispose by incineration and/or burial; these containers may be used for sharp disposal containers, but do not reuse them for any other purpose
- Equipment that is used to hold and transport wastes must not be used for any other purpose in the clinic or healthcare facility, and contaminated waste containers should be labeled clearly.
- Contaminated waste containers should be cleaned each time they are emptied and non-contaminated ones when they are visibly soiled.

REFERENCES

- Centers for Disease Control (CDC). 1985. Recommendations for preventing transmission of infection with human T-lymphotropic virus type III/lymphadenopathy-associated virus in the workplace. *MMWR* 34(45): 681-686; 691-695.
- Rutala WA. 1993. Disinfection, sterilization and waste disposal, in *Prevention and Control of Nosocomial Infections*, 2nd ed. Wenzel RD (ed). Williams & Wilkins: Baltimore, MD.
- South East Asia Regional Office (SEARO), World Health Organization. 1988. *A Manual on Infection Control in Health Facilities*. SEARO: New Delhi, pp 72-8
- World Health Organization (WHO). 1999. *Safe Management of Wastes from Healthcare Activities*. WHO: Geneva.



CHAPTER 9

INSTRUMENT PROCESSING

In working to create an infection-free environment, it is important that the rationale for each of the recommended infection prevention processes, and their limitations, be clearly understood by clinic staff at all levels—from healthcare providers to cleaning and maintenance.

Figure 9-1. Key Steps in Processing Contaminated Instruments, Gloves and Other Items

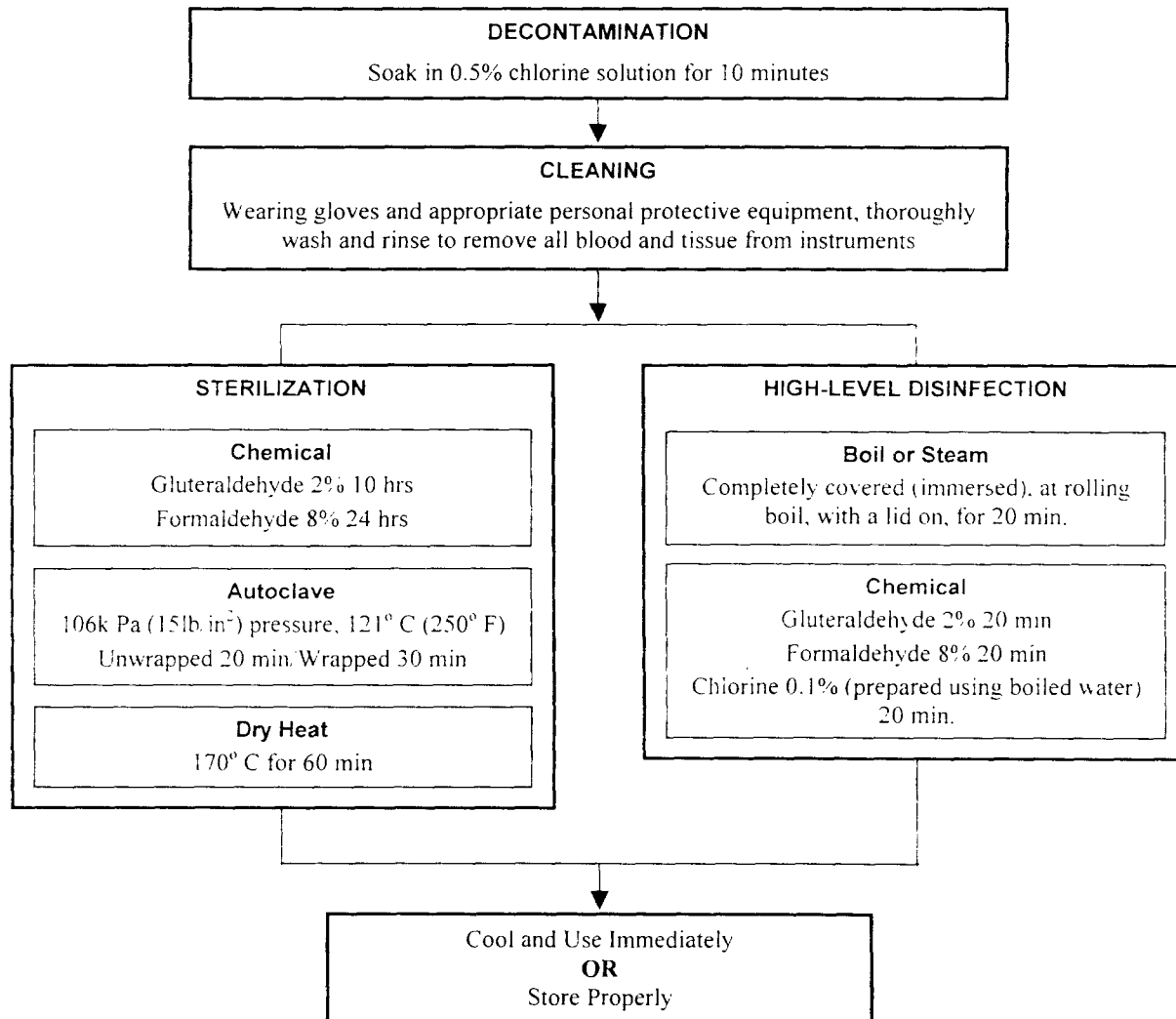

DECONTAMINATION

Decontamination is the first step in handling used instruments and gloves. Immediately after use, all instruments should be placed in an approved disinfectant such as 0.5% chlorine solution for 10 minutes to inactivate most organisms, including HBV and HIV (ARON 1990; ASHCSP 1986).

For achieving satisfactory decontamination:

- Make fresh solution every morning, or more often if the solution becomes cloudy.
- Use plastic, non-corrosive container for decontamination. This prevents, sharp instruments from getting dull due to contact with metal containers. It also prevents instruments from getting rusted due to chemical reaction (electrolysis) that can occur between two different metals when placed in water.
- **Do not** soak metal instruments in water for more than one hour, even if they are electroplated, to prevent rusting.
- **Do not** mix chlorine solutions with either formaldehyde or with ammonia-based solutions as toxic gas may be produced.

Decontaminating Hypodermic Needles, Syringes, and Large Surfaces

- Hypodermic needles and syringes that are to be disposed of should be decontaminated and placed in a puncture-resistant sharp container
- Large surfaces, such as pelvic examination or operating tables, or tables for delivery, that may have come in contact with blood and body fluid should be decontaminated using 0.5% chlorine solution.

Decontaminating Used Instruments and Other Items

1. Keep surgical or examination gloves after completing the procedure.
2. Place all instruments in 0.5% chlorine solution for 10 minutes immediately after completing the procedure.
3. Decontaminate any surface contaminated during the procedure by wiping them with a cloth soaked in 0.5% chlorine solution.
4. Immerse gloved hands in 0.5% chlorine solution.
5. Remove gloves by turning inside out. If disposing of gloves, place them in a leak proof containing or heavy-duty plastic container.
6. If reusing gloves, soak in 0.5% chlorine solution for 10 minutes for decontamination.
7. Remove instruments from 0.5% chlorine solution after 10 minutes and immediately rinse them with cool water to remove residual chlorine before being thoroughly cleaned.
8. Two buckets can be used in the procedure areas or operating rooms, one filled with 0.5% chlorine solution and one with water, so instruments can be placed in the water after 10 minutes to help prevent corrosion.

Remember: Leaving instruments in plain water for more than one hour can lead to rusting.

Steps for Making a 0.5% Chlorine Solution for Decontamination

A 0.5% chlorine solution (Barkina) can be made from readily available liquid or powder chlorine. Liquid chlorine is available under different brand names in different concentration for example "Ghion" available in Ethiopia contains 5% chlorine. Manufacturers of, widely used brand Sedex, contains 5% chlorine.

Formula for Making a Dilute Solution from Concentrated Solutions

- Determine the concentration (% concentration) of the chlorine solution
- Determine the desired concentration (% dilution)

- Check concentration (% concentrate) of the chlorine product you are using.
- Determine total parts water needed using **Table 10-1** or the following formula:

$$\text{Total Parts (TP) water} = \left[\frac{\% \text{ Concentrate}}{\% \text{ Dilute}} \right] - 1$$

- Mix 1 part concentrated bleach with the total parts water required.

Example: Make a dilute solution (0.5%) from 5% concentrated solution

STEP 1: Calculate TP water: $\left[\frac{5.0\%}{0.5\%} \right] - 1 = 10 - 1 = 9$

STEP 2: Take 1 part concentrated solution and add to 9 parts water.

Once instruments and other items have been decontaminated, they can safely be further processed. This consists of cleaning and finally either high-level disinfection or sterilization.

CLEANING

After decontamination of soiled instruments or gloves in 0.5% chlorine solution for 10 minutes, they must be cleaned to remove organic materials or chemical residue. Using liquid soap, if available, is preferable. Liquid soap removes grease, oil, and other foreign matters in solution so that they can be removed easily by the cleaning process. Abrasive cleaners used for household cleaning, including steel wool, should be avoided as they can result in scratches on the instruments which can be a potential site for harboring microorganisms.

Table 9-1 shows the effectiveness of methods for processing instruments.

Table 9-1. Effectiveness of Methods for Processing Instruments

METHOD	EFFECTIVENESS (kill or remove microorganisms)	END POINT
Decontamination	Kills HBV and HIV and most microorganisms	10 minute soak
Cleaning (water only)	Up to 50%	Until visibly clean
Cleaning (soap and rinsing with water)	Up to 80%	Until visibly clean
High-Level Disinfection	95% (does not inactivate some endospores)	Boiling, steaming or chemical for 20 minutes
Sterilization	100%	High-pressure steam, dry heat or chemical for recommended time

Cleaning Tips

- Wear gloves while cleaning instruments and equipment. (Thick household or utility gloves work well.) If torn or damaged, they should be discarded; otherwise they should be cleaned and left to dry at the end of the day for use the following day.
- Wear protective eyewear (plastic visors, face shields, goggles or glasses, protective shoes) and a plastic apron, if available, while cleaning instruments and equipment to minimize the risk of splashing contaminated fluids into the eyes and onto the body.
- To prevent splashing keep the items being washed under the surface of the water.
- Instruments should be washed with a soft brush in soapy water. Particular attention should be paid to instruments with teeth, joints, or screws where organic material can collect. After cleaning, instruments should be thoroughly rinsed with clean water to remove soap residue that can interfere with chemical disinfectants used for HLD or sterilization.

Remember: The items that cannot be cleaned thoroughly should not be reused and discarded.

STERILIZATION

Sterilization should be used for instruments, surgical gloves and other items that come in direct contact with the blood stream or normally sterile tissues. Sterilization can be achieved by physical agents such as high-pressure steam (autoclaving), dry heat, or chemical sterilants such as gluteraldehyde or formaldehyde.

Instructions for Sterilization by Autoclaving

1. Do not put plastic or rubber instruments or equipment in the autoclave unless the manufacturer's instructions say it is safe, as they will melt. Where electricity is a problem, instruments can be sterilized in a nonelectric steam sterilizer using kerosene or other fuel as a heat source.

2. Make sure that instruments and items to be sterilized have been decontaminated, cleaned and dried. All jointed instruments should be in the opened or unlocked positions, while instruments composed of more than one part or sliding parts should be disassembled.
3. Instruments should not be held tightly together by rubber bands or any other means that will prevent steam contact with all surfaces.
4. Wrap the sharp edges and needle points in a gauze before sterilizing to help prevent dulling of sharp instruments. Repair or replace instruments as needed
5. Do not allow to boil dry. Steam should always be escaping from the pressure valve.
6. If using a pressure cooker or kerosene-powered gravity displacement steam sterilizer, bring the water to a boil and let steam escape from the pressure valve; then turn down heat, but keep steam coming out of the pressure valve.
7. Sterilize at 121°C (250°F) for 30 minutes for wrapped items, 20 minutes for unwrapped items; time with a clock. Start counting time after the pressure has reached 15 Lbs/in² or 106 kPa.
8. Wait 20–30 minutes (or until the pressure gauge reads zero) to permit the sterilizer to cool sufficiently. Then open the lid or door to allow steam to escape.
9. Allow instrument packs to dry completely before removal, which may take up to 30 minutes. (Wet packs act like a wick drawing in bacteria, viruses and fungi from the environment) Wrapped instrument packs are considered unacceptable if there are water droplets or visible moisture on the outer surfaces of the packages when they are removed from the steam sterilizer chamber. If using rigid containers, close the lids tightly.
10. To prevent condensation, when removing the packs from the chamber, place sterile trays and packs on a surface padded with paper or fabric.
11. After sterilizing, items wrapped in cloth or paper are considered sterile as long as the pack remains clean, dry and intact. Unwrapped items must be used immediately or stored in covered sterile containers.
12. Do not store trays or packs until they reach room temperature. This usually takes about an hour.
13. Maintain a steam sterilizer log including, heat begun, correct temperature and pressure achieved, heat turned down, and heat turned off.
14. Each load should be monitored with mechanical (time, temperature and pressure) and chemical (internal and external chemical test strips) indicators.
15. Autoclave should be tested daily with an air-removal test to ensure proper air removal.

Guidelines for Operating and Maintaining Autoclave Machines

Instruction for operation and routine maintenance of autoclave machines should be included in the basic training of healthcare staff. An autoclave machine will reliably sterilize items only when kept in good working condition and operated correctly.

Steam Contact

To ensure proper steam contact:

- Decontaminate, clean and dry objects being sterilized as per guidelines.
- Keep instruments opened, and unlocked.
- Do not stack the instruments.
- Do not wrap the packages too tightly.
- Do not arrange the packs in the sterilizer too close to each other.
- Position the containers in a way that air can easily be displaced and steam can have enough contact with all surfaces.
- Ensure that the small drain strainer at the bottom of the sterilizer is not clogged. This may result in trapping air inside the sterilizer.
- Follow the manufacturer's manual for maintenance of the sterilizer. In some cases, however, a weekly flush of hot liquid soap through the exhaust line will keep it cleaned out.
- Appropriate Temperature (121°C all throughout the process), Timing (20 minutes for unwrapped and 30 minutes for wrapped), and adequate Moisture (100% moisture in the steam) should be ensured during any autoclaving cycle.
- To ensure correct operation, when available, consult specific operating instructions from the manual supplied by the manufacturer.

Sterilization by Dry Heat

When available, dry heat is a practical way to sterilize needles and other sharp instruments. Dry-heat sterilization can be achieved with a simple oven as long as a thermometer is used to verify the temperature inside the oven.

Instructions for Using Dry Heat for Sterilization

1. Use dry heat only for items that can withstand a temperature of 170°C/340°F (Perkins 1983).
2. Decontaminate, clean, and dry all instruments and other items to be sterilized.
3. If desired, wrap instruments in aluminum foil or place in a metal container with a tight-fitting, closed lid. Wrapping helps prevent recontamination prior to use. Hypodermic or suture needles should be placed in glass tubes with cotton stoppers. When using dry heat to sterilize items wrapped in cloth, be sure that temperature does not exceed 170°C/340°F. Needles and other instruments with cutting edges should be sterilized at lower temperatures (160°C [320°F]), because higher temperatures can destroy the sharpness of cutting edges.

4. Place loose instruments in metal containers or on trays in the oven and heat to the desired temperature.
5. After the desired temperature is reached, begin timing. The following temperature/time is recommended (APIC 2002):
 - 170°C (340°F) 60 minutes
 - 160°C (320°F) 120 minutes
 - 150°C (300°F) 150 minutes
 - 140°C (285°F) 180 minutes
 - 121°C (250°F) overnight
6. Depending upon the temperature selected, the total cycle time (preheating, sterilization time and cool down) will range from 2.5 hours at 170°C to more than 8 hours at 121°C.
7. After cooling, remove packs and/or metal containers and store in a cool dry area. Loose items should be removed with sterile forceps and used immediately or placed in a sterile container with a tight-fitting lid.

Chemical Sterilization

- Chemical sterilization is an alternative to high-pressure steam or dry-heat sterilization is chemical sterilization often called “cold sterilization”. It is useful for those items, which would get damaged by high-pressure steam or dry heat. They can be sterilized using chemicals such as Glutaraldehyde and formaldehydes. Because glutaraldehyde works best at room temperature, chemical sterilization cannot be assured in cold environments (temperatures less than 20°C/68°F), even with prolonged soaking. Formaldehyde should never be mixed with chlorine or chlorinated water because a dangerous gas (bis-chloromethyle-ether) is produced.

Instructions for Chemical Sterilization

1. Decontaminate, clean and dry all instruments and other items to be sterilized using chemical.
2. Completely submerge items in a clean container filled with the chemical solution and place the lid on the container.
3. Allow items to soak:
 - 10 hours in a glutaraldehyde (check specific product instructions), or
 - at least 24 hours in 8% formaldehyde.
4. Remove objects from the solution with sterile forceps; rinse all surfaces three times in sterile water and air dry. Ideally, three separate (sequential) rinse containers should be used.

Monitoring Sterilization Procedures

- Biological Indicators are recommended for use at regular intervals. For steam sterilizers, *Bacillus stearothermophilus*, weekly and as needed and for dry-heat sterilizers, *Bacillus subtilis*, weekly and as needed.
- Chemical Indicators include tape or labels, which monitor time, temperature and pressure for steam sterilization, and time and temperature for dry-heat sterilization.

- External indicators should be used to verify that items have been exposed to the correct conditions of the sterilization process and that the specific pack has been sterilized.
- Internal indicators are placed inside a pack or container in the area most difficult for the sterilization agent (steam or heat) to reach (i.e., the middle of the linen pack).
- Chemical indicators, such as heat sensitive tape or glass vials containing pellets that melt at certain temperatures for a given time, do not guarantee that sterilization has been achieved. They do, however, indicate whether mechanical or procedural problems in the sterilization process have occurred.
- Mechanical indicators for sterilization provide a visible record of the time, temperature and pressure for that sterilization cycle. This is usually a printout or graph from the sterilizer, or it can be a log of time, temperature and pressure kept by the person responsible for the sterilization process that day. This is most inexpensive way to make sure that sterilization process was carried out as per the guidelines.

STORAGE

All sterile items should be stored appropriately to protect them from dust, dirt, and moisture. The storage area should be located next to or connected to where sterilization occurs, in a separate enclosed area with limited access that is used just to store sterile and clean patient care supplies. In smaller clinics, this area may be just a room close to the Central Supplies Department or in the Operating Room.

Instructions for Storing Sterile Items

1. Keep the storage area clean, dry, dust-free and lint-free.
2. Control temperature and humidity (approximate temperature 24°C and relative humidity <70%) when possible.
3. Packs and containers with sterile (or high-level disinfected) items should be stored 20–25 cm off the floor, 45–50 cm from the ceiling and 15–20 cm from an outside wall.
4. Do not use cardboard boxes for storage. Cardboard boxes shed dust and debris and may harbor insects.
5. Date and rotate the supplies (first in/first out). This process serves as a reminder, but does not guarantee sterility of the packs.
6. Distribute sterile and high-level disinfected items from this area.

Shelf Life

- The shelf life of an item after sterilization is event-related. The item remains sterile until something causes the package or container to become contaminate—time elapsed since sterilization is not the determining factor.
- To make sure items remain sterile until you need them, prevent events that can contaminate sterile packs, and protect them by placing them in plastic covers (thick polyethylene bags).

- Before using any sterile item, look at the package to make sure the wrapper is intact, the seal unbroken and is clean and dry (as well as having not water stains).
- If the quality of wrapping cloth is poor and plastic bags are not available, limiting the shelf life is a reasonable option to ensure the sterility of the instruments.

HIGH-LEVEL DISINFECTION

Although sterilization is the safest and most effective method for the final processing of instruments, often sterilization equipment is either not available or not suitable. In these cases, HLD is the only acceptable alternative.

How to Prepare a HLD Container

- For small containers, boil water in the covered container for 20 minutes, then pour out the water, which can be used for other purposes, replace the cover and allow container to dry.
- Alternatively, and for large containers, fill a plastic container with 0.5% chlorine solution and immerse the cover in chlorine solution as well. Soak both for 20 minutes. Rinse the cover and the inside of the container three times with boiled water and allow to air dry. Large metal containers cannot be HLD using chemicals.

High-Level Disinfection by Boiling

- Although boiling instruments in water for 20 minutes will kill all vegetative forms of bacteria, viruses, yeast and fungi, boiling will not kill all endospores reliably.

Instructions for HLD by Boiling

1. Decontaminate, clean and dry all instruments and items to be high-level disinfected.
2. Completely immerse all items in the water. For plastic items that float on the surface of boiling water, it is not necessary that they be fully covered by the water to achieve HLD if the pot is covered with lid. Make sure all bowls and containers to be boiled are full of water.
3. Close lid over pan and bring water to a gentle, rolling boil. Boiling water too vigorously wastes fuel, rapidly evaporates the water and may damage delicate instruments or other items.
4. Start timer. In the HLD log, note time on the clock and record the time when rolling boil begins.
5. Boil all items for 20 minutes.
6. After boiling for 20 minutes, remove objects with previously high-level disinfected forceps. Never leave boiled instruments in the water that has stopped boiling.
7. Use instruments and other items immediately or, with high-level disinfected forceps or gloves, place objects in a HLD container with a tight-fitting cover. Once the instruments are dry, if any pooled water remains at the bottom of the container, remove the dry items and place them in another HLD container that is dry and can be tightly covered.

For protecting the life of instruments that are frequently boiled:

1. Boil the water for 10 minutes at the beginning of each day before use.
2. Use the same water throughout the day, adding only enough to keep the surface at least 1 inch above the instruments to be HLD.
3. Drain and clean the boiler or pot at the end of each day to remove lime deposits.

High-Level Disinfection by Steaming

Steaming surgical gloves has been used as the final step in processing gloves for many years in several countries. The effectiveness of this process has been confirmed by research. Any locally available instrument for steaming can be used for this purpose.

Figure 9-2. Example of a HLD Steamer

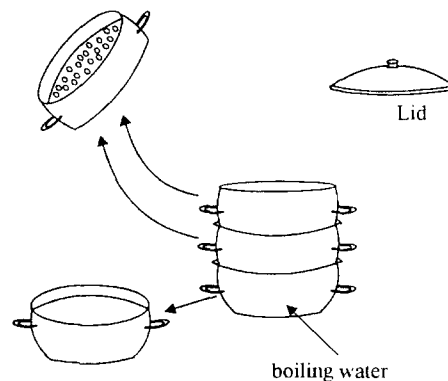

Instructions for HLD by Steaming

1. Place instruments, plastic MVA cannulae and other items in one of the steamer pans with holes in its bottom. To make removal from the pan easier, do not overfill the pan.
2. Repeat this process until up to three steamer pans have been filled. Stack the filled steamer pans on the top of a bottom pan containing water for boiling. A second empty pan without whole should be placed on the counter next to the heat source.
3. Place lid on the top pan and bring the water to a full rolling boil.
4. When steam begins to come out between the pans and the lid, start the timer or note the time on the clock and record the time in the HLD log.
5. Steam items for 20 minutes.
6. Remove the top steamer pan and put the lid on the pan that was below it. Gently shake excess water from the pan just removed.
7. Put the pan just removed onto the empty pan. Repeat until all pans are restacked on this empty pan and the top pan is covered with the lid.

8. Allow items to air dry in the steamer pan before using.
9. Using HLD forceps, transfer the dry items to a dry, HLD container with a tight fitting cover. Instruments and other items can also be stored in the stacked and covered steamer pans as long as a bottom pan (one with no holes) is used.

HLD using Chemicals

Although number of disinfectants is commercially available in most countries including Ethiopia, four disinfectants—chlorine, glutaraldehyde, formaldehyde and hydrogen peroxide—are routinely used for HLD.

Key Steps in Chemical HLD

1. Decontaminate, clean and dry all instruments.
2. Completely immerse all items in the high-level disinfectant.
3. Soak for 20 minutes (for 0.1% chlorine prepared using boiled water, 2–4% glutaraldehyde, 8% formaldehyde, and 6% hydrogen peroxide).
4. Remove items using HLD or sterile forceps or gloves.
5. Rinse well with boiled and filtered water three times and air dry.
6. Use promptly or store in a dry, HLD container with tight fitting lid.

Alcohols and iodophors are disinfectants and not high-level disinfectants and should not be used for HLD purpose. **Table 9-2** provides information on preparing and using chemical disinfectants.

Note: Chemical disinfectants should be stored in a cool, dark area.

The glass containers, used for storing chemicals, should be washed with soap, rinsed, dried and reused. Alternatively, thoroughly rinse glass containers with water and dispose of by burying. Plastic containers used for toxic substances such as formaldehyde should be rinsed with water and disposed of by burning or burying. They should never be reused. To further prevent them from being reused, put a hole in each container before disposal so that water or other liquids cannot be carried in it.

The used chemicals should be carefully poured down a utility sink drain or into a flushable toilet and rinse or flush with water. Liquid waste can also be poured into a latrine. Avoid splashing.

The products—Acridine derivatives, Cetrimide (Cetavlon[®]), Chlorohexedine gluconate and cetrimide in various concentration (Savlon[®]), Chlorinated Lime and boric acid (Eusol[®]), Chlorxynelol in alcohol (Dettol[®]) and Mercury compounds—should not be used as disinfectants. They are antiseptics, mainly used to clean the skin.

Table 9-2. Preparing and Using Chemical Disinfectants

Disinfectant (common solution or brand)	Effective Concentration	How to Dilute	Skin Irritant	Eye Irritant	Respiratory Irritant	Corrosive	Leaves Residue	Time Needed for HLD	Time Needed for Sterilization	Activated Shelf Life ^a
CHEMICALS FOR STERILIZATION OR HIGH-LEVEL DISINFECTION										
Chlorine	0.1%	Dilution procedures vary ^b	Yes (with prolonged contact)	Yes	Yes	Yes ^c	Yes	20 minutes	Do not use	Change every 14 days, sooner if cloudy.
Formaldehyde (35-40%)	8%	1 part 35-40% solution to 4 parts boiled water	Yes	Yes	Yes	No	Yes	20 minutes	24 hours	Change every 14 days, sooner if cloudy.
Glutaraldehyde (Cidex®)	Varies (2-4%)	Add activator	Yes	Yes (vapors)	Yes	No	Yes	20 minutes at 25°C ^d	10 hours for Cidex®	Change every 14-28 days; sooner if cloudy.
Hydrogen Peroxide (30%)	6%	1 part 30% solution to 4 parts boiled water	Yes	Yes	No	Yes	No	20 minutes	Do not use	Change daily; sooner if cloudy.
CHEMICALS FOR DISINFECTION (alcohols and iodophors are not high-level disinfectants)										
Alcohol (ethyl or isopropyl)	60-90%	Use full strength	Yes (can dry skin)	Yes	No	No	No	Do not use	Do not use	If container (bottle) kept closed, use until empty.
Iodophors (10% povidone-iodine) (PVI)	Approximately 2.5%	1 part 10% PVI to 3 parts water	No	Yes	No	Yes	Yes	Do not use	Do not use	If container (bottle) kept closed, use until empty.
^a All chemical disinfectants are heat and light sensitive and should be stored away from direct sunlight and in a cool place (<40°C). ^b See Tables 10-1 and 10-2 for instructions on preparing chlorine solutions. ^c Only corrosive with prolonged (>20 minutes) contact at concentrations >0.5% if not rinsed immediately with boiled water. ^d Different commercial preparations of Cidex and other glutaraldehydes are effective at lower temperatures (20°C) and for longer activated shelf life. Always check manufacturers' instructions.										
Adapted from: Rutala 1996.										

Table 9-3. Guidelines for Processing Instruments, Surgical Gloves, and Other Items

INSTRUMENTS OR OTHER ITEMS	DECONTAMINATION <i>First step in handling used items; it reduces risk of HBV, HCV and HIV viruses.</i>	CLEANING <i>Removes all visible blood, body fluids and dirt.</i>	STERILIZATION ^a <i>Destroys all microorganisms, including endospores.</i>	HIGH-LEVEL DISINFECTION ^b <i>Destroys all viruses, bacteria, parasites, fungi and some endospores.</i>
Airways (plastic)	Soak in a 0.5% chlorine solution for 10 minutes prior to cleaning. Rinse and wash immediately.	Wash with soap and water. Rinse with clean water, air or towel dry.	Not necessary	Not necessary
Ambu bags and CPR face masks	Wipe exposed surfaces with gauze pad soaked in 60-90% alcohol or 0.5% chlorine; rinse immediately.	Wash with soap and water. Rinse with clean water, air or towel dry.	Not necessary	Not necessary
Aprons (heavy plastic or rubber)	Wipe with 0.5% chlorine solution. Rinse with clean water. Between each procedure or each time they are taken off.	Wash with liquid soap and water. Rinse with clean water, air or towel dry at the end of the day or when visibly soiled.	Not necessary	Not necessary
Bed pans, urinals or emesis basins	Not necessary.	Using a brush, wash with disinfectant solution (soap and 0.5% chlorine). Rinse with clean water.	Not necessary	Not necessary
Blood pressure cuff	If contaminated with blood or body fluids, wipe with gauze pad or cloth soaked with 0.5% chlorine solution.	If soiled, wash with soap and water. Rinse with clean water, air or towel dry.	Not necessary	Not necessary
Diaphragms or fitting rings (used for sizing with clients)	Soak in 0.5% chlorine solution for 10 minutes prior to cleaning. Rinse or wash immediately.	Wash with soap and water. Rinse with clean water. Air or towel dry.	Not necessary but can be autoclaved at 121°C (250°F) 106 kPa (15 lbs/in ²) for 20 minutes (unwrapped).	<ul style="list-style-type: none"> • Steam or boil for 20 minutes. • Chemically high-level disinfect by soaking in 8% formaldehyde, or a 2-4% glutaraldehyde for 20 minutes. Rinse well in water that has been boiled.
Exam or operating room tables or other large surface areas (carts and stretchers)	Wipe off with 0.5% chlorine solution.	Wash with soap and water if organic material remains after decontamination.	Not necessary	Not necessary

Table 9-3. Guidelines for Processing Instruments, Surgical Gloves, and Other Items (continued)

INSTRUMENTS OR OTHER ITEMS	DECONTAMINATION <i>First step in handling used items; it reduces risk of HBV, HCV and HIV viruses.</i>	CLEANING <i>Removes all visible blood, body fluids and dirt.</i>	STERILIZATION ^a <i>Destroys all microorganisms, including endospores.</i>	HIGH-LEVEL DISINFECTION ^b <i>Destroys all viruses, bacteria, parasites, fungi and some endospores.</i>
Footwear (rubber shoes or boots)	Wipe with 0.5% chlorine solution. Rinse with clean water. At the end of the day or when visibly soiled.	Wash with liquid soap and water. Rinse with clean water, air or towel dry at the end of the day or when visibly soiled.	Not necessary	Not necessary
Hypodermic needles and syringes (glass or plastic)	While holding needle under the surface of 0.5% chlorine solution, fill assembled needle and syringe with solution and soak for 10 minutes prior to cleaning. Rinse by flushing three times with clean water.	Disassemble, and then wash with soap and water. Rinse with clean water, air or towel dry syringes (only air dry needles).	Preferable (glass only): <ul style="list-style-type: none"> • Dry heat for 2 hours after reaching 160°C (320°F) (glass syringes only), or • Autoclave at 121°C (250°F) and 106 kPa (15 lbs/in²) for 20 minutes (30 minutes if wrapped). 	Acceptable (glass or plastic): <ul style="list-style-type: none"> • Steam or boil for 20 minutes. (Chemical HLD is not recommended because chemical residue may remain even after repeated rinsing with boiled water. These residues may interfere with the action of drugs being injected.)
IUDs and inserters (never reuse)	Not appropriate	Not appropriate	Not recommended. Most IUDs and inserters come in sterile packages. Discard if package seal is broken.	Not recommended
Laparoscopes	Wipe exposed surfaces with gauze pad soaked in 60B90% alcohol; rinse immediately.	Disassemble, then using a brush wash with soap and water. Rinse with clean water, towel dry.	Sterilize daily using chemical sterilization. Soak in: <ul style="list-style-type: none"> • a glutaraldehyde (usually 2%) for 10 hours, or • 8% formaldehyde for 24 hours. Rinse with sterile water or water which has been boiled for 20 minutes three times.	Between cases, soak for 20 minutes in: <ul style="list-style-type: none"> • a glutaraldehyde (usually 2–4%), or • 8% formaldehyde, or • 0.1% chlorine solution with boiled and filtered (if necessary) water. Rinse three times with water that has been boiled for 20 minutes.
PPE (caps, masks, covergowns) ^d	Not necessary. (Laundry staff should wear plastic aprons, gloves and protective foot and eyewear when handling soiled linen.)	Wash with soap and hot water. Rinse with clean water, air or machine dry. Wrap for reuse.	Not necessary	Not necessary

Table 9-3. Guidelines for Processing Instruments, Surgical Gloves, and Other Items (continued)

INSTRUMENTS OR OTHER ITEMS	DECONTAMINATION <i>First step in handling used items; it reduces risk of HBV, HCV and HIV viruses.</i>	CLEANING <i>Removes all visible blood, body fluids and dirt.</i>	STERILIZATION ^a <i>Destroys all microorganisms, including endospores.</i>	HIGH-LEVEL DISINFECTION ^b <i>Destroys all viruses, bacteria, parasites, fungi and some endospores.</i>
Stethoscopes	Wipe with gauze pad soaked in 60–90% alcohol.	If soiled, wash with soap and water. Rinse with clean water, air or towel dry.	Not necessary	Not necessary
Storage containers for instruments (metal or plastic)	Soak in 0.5% chlorine solution for 10 minutes prior to cleaning. Rinse or wash immediately. ^c	Wash with soap and water. Rinse with clean water, air or towel dry.	<ul style="list-style-type: none"> • Dry heat for 1 hour after reaching 170°C (340°F), or • Autoclave at 121°C (250°F) and 106 kPa (15 lbs/in²) for 20 minutes (30 minutes if wrapped). 	Boil container and lid for 20 minutes. If container is too large: <ul style="list-style-type: none"> • Fill container with 0.5% chlorine solution and soak for 20 minutes. • Rinse with water that has been boiled for 20 minutes and air dry before use.
Suction bulbs (rubber)	Soak in a 0.5% chlorine solution for 10 minutes prior to cleaning. Rinse and wash immediately.	Wash with soap and water. Rinse with clean water, air or towel dry.	Not necessary	Not necessary
Suction cannulae (plastic) for manual vacuum aspiration (MVA)	Soak in 0.5% chlorine solution for 10 minutes prior to cleaning. Rinse or wash immediately.	Pass soapy water through cannulae three times, removing all particles.	Not recommended. (Heat from autoclaving or dry-heat ovens will damage cannulae.)	Steam or boil for 20 minutes.
Suction catheters (rubber or plastic)	Soak in 0.5% chlorine solution for 10 minutes prior to cleaning. Rinse or wash immediately.	Pass soapy water through catheter three times. Rinse three times with clean water (inside and outside).	Not recommended. (Heat from autoclaving or dry-heat ovens will damage plastic catheters; rubber catheters can be autoclaved.)	<ul style="list-style-type: none"> • Steam or boil for 20 minutes. (Chemical HLD is not recommended because chemical residue may remain even after repeated rinsing with boiled water.)
Surgical gloves	Soak in 0.5% chlorine solution for 10 minutes prior to cleaning. Rinse or wash immediately.	Wash with soap and water. Rinse with clean water and check for holes. If to be sterilized, dry inside and out (air or towel dry) and package.	If used for surgery: <ul style="list-style-type: none"> • Autoclave at 121°C (250°F), and 106 kPa (15 lbs/in²) for 20 minutes. • Do not use for 24B48 hours. 	<ul style="list-style-type: none"> • Steam for 20 minutes and allow to dry in steamer.

Table 9-3. Guidelines for Processing Instruments, Surgical Gloves, and Other Items (continued)

INSTRUMENTS OR OTHER ITEMS	DECONTAMINATION <i>First step in handling used items, it reduces risk of HBV, HCV and HIV viruses.</i>	CLEANING <i>Removes all visible blood, body fluids and dirt.</i>	STERILIZATION ^a <i>Destroys all microorganisms, including endospores.</i>	HIGH-LEVEL DISINFECTION ^b <i>Destroys all viruses, bacteria, parasites, fungi and some endospores.</i>
Surgical gowns, linen drapes and wrappers ^d	Not necessary. (Laundry staff should wear plastic aprons, gloves and protective foot and eyewear, when handling soiled linen.)	Wash with soap and hot water. Rinse with clean water, air or machine dry.	Autoclave at 120°C/250°F and 106 kPa (15 lbs/in ²) for 30 minutes.	Not practical
Surgical instruments (metal)	Soak in 0.5% chlorine solution for 10 minutes prior to cleaning. Rinse or wash immediately. ^c	Using a brush, wash with soap and water. Rinse with clean water. If to be sterilized, air or towel dry and wrap in packs or individually.	Preferable: <ul style="list-style-type: none"> • Dry heat for 1 hour after reaching 170°C (340°F)^e, or • Autoclave at 121°C (250°F) and 106 kPa (15 lbs/in²) for 20 minutes (30 minutes if wrapped). For sharp instruments: Dry heat for 2 hours after reaching 160°C (320°F). ^e	Acceptable: <ul style="list-style-type: none"> • Steam or boil for 20 minutes. • Chemically high-level disinfect by soaking for 20 minutes. Rinse well with boiled water and air dry before use or storage.
Thermometers (glass)	Not necessary	Wipe with disinfectant solution (soap and 0.5% chlorine). Rinse with clean water, air or towel dry.	Not necessary	Not necessary
Transfer forceps (chittle) and container (metal)	Soak in 0.5% chlorine solution for 10 minutes prior to cleaning. Rinse or wash immediately. ^c (Reprocess per shift or when contaminated.)	Using a brush, wash with soap and water. Rinse with clean water. If to be sterilized, air or towel dry.	Preferable: <ul style="list-style-type: none"> • Dry heat for 1 hour after reaching 170°C (340°F)^e, or • Autoclave at 121°C (250°F) and 106 kPa (15 lbs/in²) for 20 minutes (30 minutes if wrapped). 	Acceptable: <ul style="list-style-type: none"> • Steam or boil for 20 minutes. Chemically high-level disinfect by soaking for 20 minutes. Rinse well with boiled water and air dry before use.
Urinary catheters (rubber and straight metal)	Soak in 0.5% chlorine solution for 10 minutes prior to cleaning. Rinse or wash immediately. ^c	Using a brush, wash with soap and water. Rinse three times with clean water (inside and outside).	Preferable (metal only): <ul style="list-style-type: none"> • Dry heat for 2 hours after reaching 160°C (320°F), or • Autoclave at 121°C (250°F) and 106 kPa (15 lbs/in²) for 20 minutes (30 minutes if wrapped). 	Acceptable (rubber or metal): <ul style="list-style-type: none"> • Steam or boil for 20 minutes.

Table 9-3. Guidelines for Processing Instruments, Surgical Gloves, and Other Items (continued)

INSTRUMENTS OR OTHER ITEMS	DECONTAMINATION <i>First step in handling used items, it reduces risk of HBV, HCV and HIV viruses</i>	CLEANING <i>Removes all visible blood, body fluids and dirt</i>	STERILIZATION ^a <i>Destroys all microorganisms, including endospores</i>	HIGH-LEVEL DISINFECTION ^b <i>Destroys all viruses, bacteria, parasites, fungi and some endospores.</i>
Ventilator tubing or circuits	Not necessary	Using a brush, wash with soap and water. Rinse with clean water and air dry.	Not possible using an autoclave or dry heat oven.	Acceptable <ul style="list-style-type: none"> • Steam or boil for 20 minutes. • Air dry before use.
<p>^a If unwrapped, use immediately; if wrapped, reprocess if package becomes damaged or contaminated.</p> <p>^b If sterilization (dry-heat or autoclave) is not available, these items can be high-level disinfected either by boiling, steaming or soaking in a chemical disinfectant.</p> <p>^c Avoid prolonged exposure (> 20 minutes) to chlorine solution (> 0.5%) to minimize corrosion (rusting) of instruments and deterioration of rubber or cloth products.</p> <p>^d Paper or plastic gowns, caps or masks. Place in a plastic bag or leakproof, covered waste container for disposal.</p> <p>^e Instruments with cutting edges or needles should not be sterilized at temperatures above 160°C to avoid dulling.</p>				

REFERENCES

- Association for Practitioners in Infection Control (APIC). 2002. *APIC Text of Infection Control and Epidemiology on CD-ROM*. APIC: Washington, DC.
- Association of Operating Room Nurses (AORN). 1990. Clinical issues. *AORN J* 52: 613–615.
- Gruendemann BJ and SS Mangum. 2001. Ultraviolet irradiation and lights, in *Infection Prevention in Surgical Settings*. WB Saunders Company: Philadelphia, pp 32–35.
- Nyström B. 1981. Disinfection of surgical instruments. *J Hosp Infect* 2(4): 363–368.
- Rutala WA. 1996. APIC guidelines for selection and use of disinfectants. *Am J Infect Control*, 24(4): 313–342.
- Tietjen LG, W Cronin and N McIntosh. 1992. High-level disinfection, in *Infection Prevention Guidelines for Family Planning Programs*. Essential Medical Information Systems, Inc.: Durant, OK, pp 74–84.
- World Health Organization (WHO). 1989. *Guidelines on Sterilization and High-Level Disinfection Methods Effective Against Human Immunodeficiency Virus (HIV)*. AIDS Series 2. WHO: Geneva.

SECTION 10

PROCESSING LINEN

Although soiled linen may contain large numbers of microorganisms, there is little risk to health workers during linen processing. When work related infections occur, they often are due to healthcare workers not using gloves or not washing their hands during or after collecting, transporting and sorting soiled items.

No additional precautions are necessary, regardless of the patient's diagnosis, if standard precautions are used in all situations.

Principles and key steps in processing linen:

- Housekeeping and laundry personnel should wear gloves and other personal protective equipment as indicated when collecting, handling, transporting, sorting and washing soiled linen.
- When collecting and transporting soiled linen, handle it as little as possible and with minimum contact to avoid accidental injury and spreading of microorganisms.
- Consider all cloth items (e.g., surgical drapes, gowns, wrappers) used during a procedure as infectious. Even if there is no visible contamination, the item must be laundered.
- Carry soiled linen in covered containers or plastic bags to prevent spills and splashes, and confine the soiled linen to designated areas (interim storage area) until transported to the laundry.
- Carefully sort all linen in the laundry area before washing.

Remember: Do not presort or wash linen at the point of use.

USE OF PERSONAL PROTECTIVE EQUIPMENT

Utility gloves, plastic or rubber apron and protective eyewear and closed shoes that protect feet from dropped items and spilled blood and body fluids should always be used when collecting and handling, transporting, sorting, hand washing soiled linen or loading in automatic washers.

Collecting and Transporting Soiled Linen

After invasive medical or surgical procedures or when changing linen in patient rooms:

- Collect used linen in cloth or plastic bags or containers with lids. If linen is heavily contaminated with blood or body fluids, carefully roll the contaminated area into the center of the linen and place in a leak proof bag or container with a lid.
- Cloth bags are adequate for the majority of the patient care linen. They require the same processing as their contents.

- Handle soiled linen as little as possible and do not shake it. This helps prevent spreading microorganisms to the environment, personnel and other patients.
- It is not necessary to double-bag or use additional precautions for used linen from patients in isolation.
- Do not sort and wash soiled linens in patient care areas.
- Collect and remove soiled linen after each procedure on daily basis or as needed including patient rooms.
- Transport collected soiled linen in closed leak proof bags, containers with lids or covered carts to the processing area daily or as needed.
- Transport soiled linen and clean linen separately. If there are separate carts or containers available for soiled and clean linen, they should be labeled accordingly. If not, thoroughly clean the containers or carts used to transport soiled linen before using them to transport clean linen.

Sorting Soiled Linen

- The processing area for soiled linen must be separate from other areas such as those used for folding and storing clean linen.
- Ensure adequate ventilation and physical barriers between the clean and soiled linen areas
- Always wear protective eyewear, utility gloves, appropriate footwear and plastic or rubber apron while handling soiled linen.
- Be watchful about scalpels, sharp tipped scissors, hypodermic and suture needles.
- Wash hands after removing the gloves.

Laundering Linen

All linen items including bed sheets, surgical drapes, masks, gowns should be thoroughly washed before reuse. Decontamination of linen prior to washing is not necessary unless linen is heavily soiled and will be hand washed.

The workers should not carry wet, soiled linen close to their body even though they are wearing a plastic or rubber apron.

The storage time for soiled linen before washing is related to practical issues, such as available space and aesthetics, not to infection prevention practices.

Handwashing Linen

- Wash heavily soiled linen separately from nonsoiled linen.
- Wash the entire item in water with soap to remove all soilage, even if not visible.
- Use warm water and add bleach to aid cleaning and bactericidal action. Also add some sour (mild acetic acid) to prevent yellowing of linen, if available.

Remember: Presoaking in soap, water and bleach is necessary only for heavily soiled linen.

- Check items for cleanliness. Rewash if it is dirty or stained.
- Rinse linen with clean water.

Machine Washing

- Wash heavily soiled linen separately from nonsoiled linen.
- Follow manufacturer's instruction for operating the machine.
- Do not overload the machine.
- Use hot water, bleach and sour as discussed above.
- Heavily soiled linen may need two cycles if not found visibly clean at the end of first cycle.
- Air dry or machine dry before further processing.

Drying, Checking And Folding Linen

- Linen can be machine dried or air dried in direct sunlight, if possible, keeping the fabric off the ground, away from dust and moisture.
- After the linen is dry, check for holes and threadbare areas. If damaged, either discard or repair before reuse.
- The linen that is not going to be sterilized should be ironed and folded. If surgical drapes are to be sterilized, do not iron. Ironing dries out the material, making autoclaving more difficult.

Storing Transporting and Distributing Clean Linen

- Keep clean linen in clean, closed storage area
- Use physical barriers to separate folding and storage rooms from soiled areas
- Keep shelves clean
- Handle stored linen as little as possible
- Clean and soiled linen should be transported separately
- Containers or carts used to transport soiled linen should be thoroughly cleaned before using the same for transporting clean linen
- Clean linen must be wrapped or covered during transport to avoid contamination
- Protect clean linen until it is distributed, do not leave extra linen in patient's area
- Handle clean linen as little as possible
- Avoid shaking clean linen. It releases dust and lint into the room
- Clean soiled mattresses before putting clean linen on them

Sterilization is a preferred end process for surgical gowns, linen drapes and wrappers.

REFERENCES

Centers for Disease Control (CDC). 1988. Update: Universal precautions for prevention of transmission of HIV, HBV, and other bloodborne pathogens in health setting. *MMWR*: 37(24): 377.

Economics Report. 1994. In-house laundry/linen reprocessing: Who does it? *Health Facilities Management* 7(6): 126.

Occupational Safety and Health Administration (OSHA), US Department of Labor. 1991. Occupational exposure to bloodborne pathogens: Final rule. *Fed Regist* 56(235): 64004–64182.

TRAFFIC FLOW AND ACTIVITY PATTERN

Microbial contamination is minimized by reducing the number of people permitted into an area and by defining the activities that take place there.

The traffic flow should be limited in procedure areas, surgical units, and work areas (where instruments are processed. These include dirty and clean areas where soiled instruments, equipments and other items are first cleaned and then processed and stored.). It is important to direct activity patterns and traffic flow in above-mentioned areas to keep contaminated areas separate from areas where procedures take place.

The space, equipment, and need for a well defined traffic flow and activity pattern become progressively more complex as the type of surgical procedure changes from general surgery and obstetric to open heart surgery.

The space requirements for these facilities are:

- Changing room and scrub area for clinic staff
- Preoperative area where clients are examined and evaluated prior to surgery
- Operating room
- Recovery area for patient observation after surgery (may be combined with the preoperative area)
- Processing area for cleaning and sterilizing or high-level disinfecting instruments and other items
- Space for storing sterile packs and/or high-level disinfected containers of instruments and other items

The recommended infection prevention practices for minimizing microbial contamination of specific areas in healthcare facilities are briefly described below.

PROCEDURE AREA

- Limit traffic to authorized staff and patients at all times.
- Permit only the patient and staff performing and assisting with procedures in the procedure room. The number of trainees should be kept to minimum possible.
- Patients can wear their own clean clothing, if not so, healthcare facility may provide cloths. However, for the patients undergoing major surgical procedures, healthcare facility should provide hospital clothes.
- Staff should wear attire and personal protective equipment according to the procedure performed.
- Have a covered container filled with a 0.5% solution for immediate decontamination of instrument and other items once they are no longer needed.

- Have a leakproof, covered waste container for disposal of contaminated waste items.
- Have a puncture-resistant container for safe disposal of sharps at point of use.
- Have storage space in procedure rooms for clean, high-level disinfected and sterile supplies.

SURGICAL UNIT

The surgical unit is divided into four designated areas, unrestricted area (a point through which staff, patients and materials enter the surgical unit), transition zone (where staff put on surgical attire), semi restricted area (a peripheral area of surgical unit and includes preoperative and recovery rooms, storage space for sterile and HLD items, and corridors leading to the restricted area) and restricted area (consists of the operating room and scrub sinks).

Environmental controls and use of surgical attire increase as one moves from unrestricted to restricted area. Staff with respiratory or skin infection and uncovered open sores should not be allowed to work in the surgical unit.

Unrestricted area needs no special traffic flow, whereas transition zone should allow only the authorized staff (Staff who perform or assist procedures in the procedure rooms). Displaying a signboard in local language limiting the entry of unauthorized persons may work in some facilities.

SEMIRESTRICTED AREA

- Limit traffic to authorized staff and patients at all times
- Have a work area for processing of clean instruments
- Have storage space for clean and sterile or HLD supplies with enclosed shelves
- Have door limiting access to the restricted area of the surgical units
- Staff who work in this area should wear surgical attire and a cap

RESTRICTED AREA

- Limit traffic to authorized staff (staff who perform and assist procedures) and patients at all times
- Keep the door closed at all times, except during movement of staff, patients, supplies and equipment
- Scrubbed staff must wear full surgical attire and cover head and facial hair with a cap and mask
- Staff should wear clean, closed shoes
- Masks are required when sterile supplies are opened and scrubbed staff are operating
- Patients entering the surgical unit should wear clean gowns or be covered with clean linen, and have hair covered

OPERATING ROOMS

- Enclose the operating room to minimize dust and eliminate flies.
- The operating room should be located away from areas of the hospital or healthcare facility that are heavily traveled by staff and patients.

Before Surgery

- Place a clean, covered container filled with 0.5% chlorine solution for immediate decontamination of used instruments
- Place a plastic bag or leakproof, covered waste container for contaminated waste items
- Place a puncture-resistant container for the safe disposal of sharps at the point of use but without contaminating the sterile field
- Place leakproof, covered waste container for soiled linen away from sterile items.
- Organize tables, both Mayo and ring stand side by side in an area away from the traffic pattern and at least 45 cm from walls, cabinets and other nonsterile surfaces
- Place a clean sheet, a lift sheet and arm board covers on the operating room bed
- Check and set up suction, oxygen and anesthesia equipment
- Place supplies and packages that are ready to open on the tables, not on the floor
- Mayo stand and other nonsterile surfaces that are to be used during the procedure should be covered with a sterile towel or cloth

During Surgical Procedures

- Limit the number of staff entering the operating room only to those necessary to perform the procedure and to patients. Minimize the outside help during the procedure
- Keep doors closed all times
- Keep the number of people and their movements to a minimum
- Keep talking to a minimum
- Scrubbed staff should wear full surgical attire—scrub suits, plastic apron, clean cap and mask protective eyewear, clean closed shoes, and sterile surgical gloves
- Scrubbed staff should keep their arms and hands within the operative field at all times
- Nonscrubbed staff should wear surgical attire—cap, clean closed shoes, mask, and protective eyewear.
- Nonscrubbed staff should stay at the periphery of the operating room
- Clean accidental spills or contaminated debris in areas outside the surgical field with a 0.5% chlorine solution as promptly as possible

After Surgery

Surgical procedure staff wearing utility gloves should:

- Collect all waste and remove it from the room in closed leakproof container
- Close and remove puncture resistant container when they are three quarter full
- Remove covered container with a 0.5% chlorine solution, with instruments and surgical gloves in it, from operating room
- Remove soiled linen
- Remove waste, soiled linen, soiled instruments and equipment, and supplies that have been opened but not used, in an enclosed cart for reprocessing

WORK AREA FOR INSTRUMENT PROCESSING

Work area consists of four areas—“dirty” receiving/cleanup area, clean work area, the cleaned equipment storage area, and sterile or HLD storage area.

Dirty receiving/cleanup area should have:

- A receiving counter
- Two sinks if possible with a clean water supply, and
- A clean equipment counter for drying

Clean work area should have:

- A large work table
- Shelves for holding clean and packaged items, and
- A high-pressure autoclave, a dry-heat oven, a steamer or a boiler

Clean equipment storage area should have:

- Shelves for storing clean equipment, and
- An office or desk for record keeping

Sterile or HLD Storage Area

This area should be separated from the sterilization area.

- Limit access to the storage area and/or store items in closed cabinets or shelves
- Keep storage area clean, dry, dust-free and lint-free by regular housekeeping
- Packs and containers with sterile or HLD should be stored 20–25 cm off the floor, 45–50 cm from the ceiling and 15–20 cm from an outside wall
- Do not use cardboard boxes for storage

- Date and rotate the supplies
- Before dispensing any item that has been stored, check the package to be sure it is not dirty, wet, or damaged
- Dispense sterile and high-level disinfected articles from this area
- Touch or handle sterile packages as little as possible

The packs will remain sterile as long as the integrity of the package is maintained. Sterile or HLD containers will remain so until they are opened.

REFERENCES

Belkin NL. 1997a. Textiles of Today: Their Influence on Sterilization and Shelf-Life, Part I. www.cea.purdue.edu/IAHCSMM/25LESSON.HTM.

Belkin NL. 1997b. Textiles of Today: Their Influence on Sterility and Shelf-Life, Part II. www.cea.purdue.edu/IAHCSMM/26LESSON.HTM.

Russell AD, WB Hugo and GA Ayliffe. 1982. *Principles and Practice of Disinfection, Preservation and Sterilization*. Blackwell Scientific Publications: Oxford, England.

South East Asia Regional Office (SEARO), World Health Organization (WHO) 1988. *A Manual on Infection Control in Health Facilities*. SEARO: New Delhi, India, pp 39–42.



CHAPTER 12

HOUSEKEEPING

Housekeeping refers to the general cleaning of hospitals and clinics, including the floors, walls, and certain types of equipment, tables and other surfaces. The purpose of general housekeeping is to:

- Reduce the number of microorganisms that may come in contact with patients, visitors, staff and the community; and
- Provide a clean and pleasant atmosphere for patients and staff.

GENERAL PRINCIPLES OF CLEANING

- Scrubbing (frictional cleaning) is the best way to physically remove dirt, debris and microorganisms.
- Cleaning is required prior to any disinfection process because dirt, debris and other materials can decrease the effectiveness of many chemical disinfectants.
- Cleaning products should be selected on the basis of their use, efficacy, safety, and cost.
- Cleaning should always progress from the least soiled areas to the most soiled areas and from high to low areas, so that the dirtiest areas and debris that fall on the floor will be cleaned up last.
- Dry sweeping, mopping, and dusting should be avoided to prevent dust, debris and microorganisms from getting into the air and landing on clean surfaces. Airborne fungal spores are especially important as they can cause fatal infections in immunosuppressed patients (Arnow et al 1991).
- Mixing (diluting) instructions should be followed when using disinfectants. (Too much or too little water may reduce the effectiveness of disinfectants.)
- Cleaning methods and written cleaning schedules should be based on the type of surface, amount and type of soil present, and the purpose of the area.
- Routine cleaning is necessary to maintain a standard of cleanliness. Schedules and procedures should be consistent and posted.

When selecting a disinfectant or other cleaning product, consider the factors like, intended use, efficacy, acceptability, safety and cost.

HOW TO PREPARE DISINFECTANT CLEANING SOLUTION

Although chlorine-containing solutions are excellent, inexpensive disinfectants. They should not be mixed with cleaning solutions containing an acid, ammonia or ammonium chloride. Doing so will release chlorine gas and other byproducts that can be toxic. 0.5% chlorine solution is ideal for cleaning purpose. Alternatively 1–2% phenols or 5% carbolic acid can be used as disinfectant for the purpose of cleaning. Adding enough detergent to these disinfectants will make a mild, soapy cleaning solution.

CLEANING METHODS

Wet mopping is the most common and preferred method to clean floors. Single, double, or triple-bucket techniques can be used for cleaning the floors. While using single bucket the solutions should be changed when dirty. The double-bucket technique extends the life of the cleaning solution and saves both labor and material costs.

Flooding followed by wet mopping is recommended in the surgical suite, if possible. Flooding the floor with disinfectant solution is best done at times when foot traffic is minimal.

Dusting is most commonly used for cleaning wall, ceilings, doors, windows, furniture and other environmental surfaces. Wet mopping is best suited for the purpose of removing the dust from any surfaces. Dry dusting should be avoided and dust clothes and mops should never be shaken to avoid the spread of microorganisms

Personal protective equipment (PPE) like utility gloves and shoes that protect the feet from accidental injuries, and plastic aprons, mask and protective eyewear should be used at all times during cleaning.

GUIDELINES FOR CLEANING SPECIFIC AREAS

- **Walls, windows, ceilings and doors, including door handles:** Spot clean whenever visibly dirty using a wet mop. Routine damp dusting is adequate and no special cleaning is required.
- **Chairs, lamps, tables, tabletops, beds, handrails, grab bars, lights, tops of the doors and counters:** Wet mop with damp cloth using disinfectant cleaning solution. Pay attention to contaminated areas on these surfaces.
- **Noncritical equipment:** Items like stethoscopes and blood pressure cuffs should be wiped with a damp cloth, detergent and water whenever visibly dirty or everyday. If they become soiled with blood or body fluids or the patient under contact precautions, it should be cleaned and disinfected using alcohol before reuse.
- **Floors:** Floors should be cleaned as frequently as needed with a wet mop, detergent and water using double-bucket technique. A disinfectant should be used when contamination is present.
- **Sinks:** Scrub frequently with separate mop, cloth or brush and a disinfectant cleaning solution.
- **Toilets and latrines:** Scrub frequently with separate mop, cloth or brush and a disinfectant cleaning solution.
- **Patient rooms:** Clean daily and after patient discharge, using the processes described above. Same cleaning process applies to rooms of patients under isolation precautions. Any equipment used for cleaning the rooms of patients under isolation precautions should be disinfected before using in other room.
- **Procedure room:** Wipe horizontal surfaces, equipment, and furniture used for the procedure with a disinfectant cleaning solution after each procedure and whenever visibly soiled.
- **Curtains:** Change and clean curtains according to the routine schedule and when visibly dirty.

- **Laboratory:** Wipe counter tops with a disinfectant cleaning solution after each shift and whenever visibly soiled. Clean blood or other body fluid spills as described below.

Cleaning Spills of Blood and Other Body Fluids

Clean spills of blood, body fluids and other potentially infectious fluids immediately:

- For small spills, while wearing utility or examination gloves, remove visible materials using a cloth soaked in 0.5% chlorine solution.
- For large spills, flood the area with a 0.5% chlorine solution, mop up the solution and then clean as usual with detergent and water.

Schedule and Procedures for the Operating Room

Do not dry mop or sweep the operating room. At the beginning of each day, all flat surfaces should be wiped with a clean, lint free moist cloth to remove dust and lint. Total cleaning is not necessary between each case for surgical procedures. Total cleaning or terminal cleaning of the operating room should be done at the end of each day.

All areas of surgical suite, scrub sinks, scrub or utility areas, hallways and equipment should be totally cleaned, regardless of whether they were used during the last 24 hours.

- Use freshly prepared 0.5% chlorine solution for decontamination purpose.
- At the end of each day remove all contaminated waste containers and replace with clean containers.
- Close and remove sharp containers if they are three quarters full. Remove soiled linen in closed leakproof containers.
- Wipe all surfaces from top to bottom using disinfectant cleaning solution.
- Any surfaces that might have come in contact with blood or body fluids of the patients should be wiped with 0.5% chlorine solution. Then clean with disinfectant cleaning solution and let them dry.

If walls and ceilings are deteriorating or damp, cover with lean plastic sheets during procedure.

Fumigation with dilute formaldehyde solution to reduce microbial contamination of environmental surfaces such as walls, ceilings and floors is not effective. Over and above it is time consuming and fumes are toxic. Scrubbing with a disinfectant and cleaning is a safer, quicker and more effective way to reduce microbial contamination on these surfaces.

Between each case:

- Clean spills with 0.5% cleaning solution, if spills are large flood the area with 0.5% chlorine solution.
- Wipe all surfaces and mattress pads with a disinfectant cleaning solution.
- Wipe all the flat surfaces that have come in contact with a patient or body fluids with a disinfectant cleaning solution.

- Mop the center of operating room surrounding the operating room bed with disinfectant cleaning solution.
- Collect and remove all waste from the operating room in closed leakproof containers.
- Close and remove containers from the operating room when they are three quarters full.
- Remove covered containers with 0.5% chlorine solution with instruments and replace them with clean container with a fresh 0.5% chlorine solution.
- Remove soiled linen in a leakproof, covered, waste container.

CLEANING SOILED AND CONTAMINATED CLEANING EQUIPMENT

- Decontaminate cleaning equipment that has been contaminated with blood and body fluids.
- Wash cleaning buckets, cloths, brushes and mops with detergent and water daily, or sooner if visibly dirty.
- Rinse in clean water.
- Dry completely before reuse.

REFERENCES

Arnow P et al. 1991. Endemic and epidemic aspergillosis associated with in-hospital replication of *Aspergillus* organisms. *J Infect Dis* 164(5): 998–1002.

Centers for Disease Control and Prevention (CDC). 1991. Chlorine gas toxicity from mixture of bleach with other cleaning products. *MMWR* 40(36): 619–621.

Chou T. 2002. Environmental Services, in *APIC Text of Infection Control and Epidemiology*. Association for Professionals in Infection Control and Epidemiology (APIC): Washington, DC, pp 73–81.

CLINICAL LABORATORY SERVICES

Any laboratory worker who handles blood or potentially infected body fluids is at some risk of accidental injury or exposure. The staff working in clinical laboratories or research units isolating or handling pathogenic microorganisms are at the greatest risk.

Biosafety Level Guidelines: Combination of primary and secondary containment and safety guidelines designed for use in microbiology laboratories and bacteriology research units functioning at four levels (BSL-1 to BSL-4) of increasing risk:

- **BSL-1** is the lowest level of containment and microbiologic safety guidelines and is entirely based on standard laboratory practices. These guidelines are recommended for those working with microorganisms, such as *Bacillus subtilis*, that are not known to cause infections in healthy adults.
- **BSL-2** is generally applied in bacteriology laboratories working with agents (e.g., *Salmonella* species) associated with human diseases of varying severity. When standard microbiologic practices are applied, the agents may be handled on open benches, especially if primary barriers, such as facemasks, gowns and examination gloves, are used when appropriate. The use of biologic safety cabinets (BSCs) and safety centrifuges may be necessary.
- **BSL-3** is aimed at containing hazardous microorganisms primarily transmitted by the airborne route (aerosols and droplets), such as tuberculosis or varicella (chicken pox). Laboratory staff that work in these situations must be trained in the use of appropriate equipment, including suitable ventilation systems and the use of BSCs.
- **BSL-4** is designed for use where agents causing life-threatening or untreatable diseases that can affect the laboratory worker via the airborne route are present, such as hemorrhagic fever viruses. Trained workers using BSCs or wearing full-body, air-supported positive pressure suits must perform all procedures in these laboratories. In addition, the facility itself must be totally isolated from other laboratories and have specialized ventilation and waste management systems.

Inhalation, ingestion, puncture wounds, and contamination of skin and mucous membrane are most common ways infections from pathogenic organisms occur among laboratory workers. Wearing a simple plastic facemask or shield can minimize these risks. Sharps should be handled with care and disposed of immediately after use in sharps containers located close to the work area.

GENERAL BIOSAFETY AND INFECTION PREVENTION GUIDELINES

- Wear new examination gloves when handling blood, body fluids and/or specimens containing pathogenic microorganisms.
- Eating, drinking or smoking should not be permitted in the laboratory.
- Food should not be stored in refrigerators used for clinical or research specimens.
- No mouth pipetting is permitted; use proper mechanical devices (e.g., suction bulbs).

- Do not open centrifuges while still in motion.
- Always cover the end of blood collection tubes with a cloth or paper towel, or point them away from anyone's face when opening.
- Decontaminate work surfaces daily or when contaminated, such as after spills, with a 0.5% chlorine solution.
- Wear protective face shields or masks and goggles if splashes and sprays of blood, body fluids, or fluids containing infectious agents are possible.
- Wear heavy-duty or utility gloves when cleaning laboratory glassware.
- Use puncture-resistant, leakproof containers for sharps.
- Place infectious waste materials in plastic bags or containers.

BLOOD DRAWING (PHLEBOTOMY)

Blood drawing is considered to be one of the highest risk procedures so far as accidental exposure blood and injuries are concerned (CDC). When collecting a blood specimen be sure to:

- Wear examination gloves
- Have assistance when patients might be uncooperative
- Have assistance for holding children when doing heel sticks

REFERENCE

Exposure Prevention Information Network (EPINet) Data Reports. 1999. *Uniform Needlestick and Sharp Object Injury Report 21 Hospitals, 1999*. International Healthcare Worker Safety Center, University of Virginia. Available on: www.med.virginia.edu/epinet/soi99.html

BLOOD BANK AND TRANSFUSION SERVICES

Blood bank and transfusion services collect, process, store and provide human blood intended for transfusion, perform pre-transfusion testing and, finally, infusion into a patient. Staff working in blood banks and transfusion services is also at risk of accidental injury or exposure to contaminated blood or blood products.

Blood bank and transfusion services involve:

- Selecting donors and assuring that they have given informed consent
- Collecting blood from screened donors
- Testing for blood components, antibodies and infectious disease
- Storing and transporting blood
- Pretransfusion testing of patient's blood
- Transfusing patients

DONOR SELECTION AND INFORMED CONSENT

- Complete the medical history and physical examination of each donor. (This should include any medical problems, behaviors, or events that put a person at risk of being infected and transmitting a serious disease to the person receiving the transfusion.)
- Prior to collection of blood, the elements of the donation process should be explained to the potential donor in simple, easy to understand language.
- Explain about the risks of venipuncture, potential adverse responses to drawing 400–500 ml of blood.
- Explain the laboratory tests that will be performed. How exactly the donor will be informed about the test results including any other medical abnormalities.
- Perform the routine laboratory test including hemoglobin, or hematocrit, HIV, HBV, HCV, syphilis, and malaria.
- Complete a written informed consent form should be completed for each donor.

BLOOD COLLECTION

1. Make sure all items are available:
 - Blood collection set consisting of sterile plastic bag containing a sufficient amount of anticoagulant for the quantity of blood to be collected
 - IV tubing and large gauge hypodermic needles
 - Pair of sterile or HLD surgical gloves
 - Clean tourniquet or blood pressure cuff
 - Antiseptic solution and sterile or clean gauze squares or cotton swabs

- Surgical tape
 - Towel to place under patient's hand or forearm
 - Basin of clean warm water
 - Soap
 - Clean dry towel to wash patient's arm if visibly soiled
 - Plastic bag or leakproof, covered waste container for disposal of contaminated items
 - Puncture-resistant sharps container
2. Explain the procedure to the donor.
 3. Identify the best vein for inserting the IV needle (a prominent, large and firm vein).
 4. Put the tourniquet or blood pressure cuff on the upper arm about 9 cms above the antecubital space to confirm that the vein is visible and then release the tourniquet or cuff.
 5. If the venipuncture site is visibly soiled, first wash it with soap and clean water and dry with a clean cloth or ask the donor to wash the forearm.
 6. Wash hands and dry with a clean towel or air dry (Alternatively use alcohol handrub—5 ml and rub both hands vigorously until dry).
 7. Place the donor's arm on the clean towel and cleanse an area about 3 cm in diameter with an antiseptic solution. Use a circular motion outward from the proposed needle insertion site over the vein. (If using povidone iodine or other iodophors, allow 2 minutes for antiseptic to take full effect.)
 8. Do not touch the area after applying the antiseptic solution.
 9. Put the tourniquet or blood pressure cuff on the upper arm again, raise the pressure up to 40–60 mm of mercury while collecting the blood.
 10. Put sterile or HLD surgical gloves on both hands.
 11. Insert the hypodermic needle into the vein without touching the skin if possible, release the tourniquet or cuff and then secure the needle by placing a short piece of tape across the blood collection tubing below the area cleansed with antiseptic.
 12. When required amount of blood has been obtained, remove the needle without touching the barrel or tip of the needle and place it in a puncture resistant sharps container.
 13. Cover the insertion site with a 2x2 gauze square, and apply pressure until bleeding stops and secure gauze square using 1 or 2 pieces of surgical tape.
 14. Prior to removing gloves, place any blood-contaminated waste items in a plastic bag or leakproof, covered waste container.
 15. Wash hands or use an antiseptic handrub as above.
 16. Have patient remain resting on a bed or in the donor chair for several minutes.
 17. Provide the donor with something to drink and eat.

18. Tell the donor to drink more fluid during the next 24 hours and avoid alcohol or smoking until more food has been eaten. Ask the donor to lie down if there is dizziness or nauseating sensation.

To avoid contamination of collected blood:

- Maintain appropriate storage conditions (stored at 1–6°C and monitoring temperature every four hours).
- Test the blood unit without entering the closed collection system.
- Infuse or discard the blood unit within a short period once the closed system has been opened.

BLOOD COMPONENT AND INFECTIOUS DISEASE TESTING

- ABO blood group and Rh type
- Blood from donor with history of transfusions or pregnancy should be tested for unexpected antibodies to red cell antibodies using methods to demonstrate clinically significant antibodies
- Human immunodeficiency virus by testing for antibodies to HIV-1 and 2. As per the national policy on HIV/AIDS for Ethiopia, All donated blood shall be screened prior to transfusion. In remote areas where testing facilities are limited, simple and/or rapid HIV tests shall be made available. Blood donors shall be informed about the tests, which will be carried out on the donated blood. In case of a donor wanting to know his/her HIV serostatus, he/she shall be referred to the appropriate health facilities for counseling and testing.
- Syphilis by screening with Rapid Plasma Reagent (RPR) test
- Hepatitis B and Hepatitis C virus by testing for Hepatitis B surface antigen

BLOOD STORAGE AND SHORT DISTANCE TRANSPORT

- Blood units must be stored in a refrigerator at 1–6°C.
- There must be a system to monitor temperatures continuously and record them at least every 4 hours.

DISCARDING BLOOD THAT HAS BEEN EXPOSED TO HIGHER TEMPERATURES

While doing this:

- Wear examination or utility gloves and protective eyewear
- Pour content down a utility sink drain, onto a flushable toilet or latrine
- Place empty blood bags and tubing in a leakproof container
- Dispose by burning or burying

PRETRANSFUSION TESTING AND CROSS-MATCHING

- Test a sample of recipient blood using the same methods and recommended infection prevention practices used to test donor blood
- Repeat testing of the donor blood to confirm the ABO group and Rh
- Crossmatch the red cells of selected donor against the serum or plasma of the recipient to be sure there are no ABO and Rh incompatibility.

TRANSFUSION OF BLOOD OR BLOOD COMPONENTS

Indications for blood transfusion are:

- Actively bleeding patients, and
- Patients with chronic or symptomatic anemia.

The generally accepted hemoglobin level for transfusing patients with acute blood loss is 7 gm%, with those patients having a level of 6 gm% almost always requiring transfusion but those with a level of 10 gm% rarely need it.

Transfusing Patients

Before starting the transfusion:

- Explain the procedure to the patient if he/she is conscious.
- Correctly identify the blood product and the patient: confirm patient's name, check compatibility information attached to the blood bag, and expiry date, check the ABO Rh of the patient on the patient chart, double check blood or type of blood product with the physician's order, check blood for clots.
- Record baseline pulse and blood pressure.
- Ask patient or relatives to report chills, headaches, itching or rash immediately.
- Once the transfusion has started, take patient's pulse, blood pressure every 5 minutes for the first 15 minutes and hourly thereafter, observe the patient for flushing, itching, difficulty in breathing, hives (clear fluids filled lesions on the skin) or other rash when checking for the vital signs.

Preventing Complications and Nosocomial Infections

To preventing complications and nosocomial infections in patients:

- Avoid unnecessary transfusions
- Screen donors for serious bloodborne infections (HIV, HBV, HCV, Syphilis)
- Collect donor blood aseptically into a closed system to minimize contamination, and accomplish all steps in processing the blood within this closed system

- Store blood and blood products at the correct temperature and make sure the unit is within the expiry date
- Take all steps to ensure that donor and patient blood are compatible in terms of ABO, Rh and crossmatching
- Verify all information matching the blood with the intended recipient
- Use aseptic techniques to establish the peripheral IV line for giving the transfusion
- Monitor patients vital signs regularly and check for any adverse reactions
- Stop transfusion immediately in the event of adverse reactions

Protecting Healthcare Workers

Wear gloves while collecting, testing and transfusing blood. Handle the sharps carefully and dispose immediately in puncture resistant container. Wear personal protective equipment at all times.

Improving performance and compliance with recommended policies and guidelines can be significantly enhanced if, there is:

- A consistent support by hospital administrators to improve the quality of services,
- Supervisors regularly provide positive feedback and rewards, and suggestions for improvement, and
- Physicians and other senior staff and faculty role model the practices and behaviors by actively supporting the policies and guidelines.

REFERENCES

American Association of Blood Banks (AABB). 2002. *Standards For Blood Banks and Transfusion Services*, 21st ed. American Association of Blood Banks: Bethesda, MD.

American Society of Anesthesiologists Task Force (ASATF). 1996. Practice guidelines for blood component therapy. *Anesthesiology* 84(3): 732–747.

Lipscomb J and R Rosenstock. 1997. Healthcare workers: protecting those who protect our health. *Infect Control Hosp Epidemiol* 18(6): 397–399.



ISOLATION PRECAUTION GUIDELINES FOR HEALTHCARE FACILITIES

Although the spread of infectious disease in hospital has been recognized for many years, understanding how to prevent nosocomial infection and implementing policies and practices that are successful have been more difficult. Standard Precautions, which apply to all clients and patients attending healthcare facilities, and Transmission-Based Precautions, which apply primarily to hospitalized patients (Garner and HICPAC 1996). There are three major routes of transmission of infectious diseases, airborne, droplet and contact.

TRANSMISSION BASED PRECAUTIONS

The isolation precautions guidelines involve a two level approach, first the Standard Precautions, apply to all clients and patients attending healthcare facilities, and the second, Transmission Based Precautions which apply primarily to hospitalized patients. In all situations, whether used alone or in combination, Transmission-Based Precautions must be used in conjunction with the Standard Precautions. Transmission-Based Precautions include air, droplet and contact precautions. Protective isolation of immunocompromised patients, such as those with AIDS, is not effective way to reduce the risk of cross-infection.

AIRBORNE PRECAUTIONS

The airborne precautions are designed to reduce the nosocomial transmission of particles 5 μm or less in size that can remain in the air for several hours and be widely dispersed. They are effective in preventing infections like Tuberculosis, Chicken pox and measles. They are recommended for patients with either known or suspected infections that could be transmitted by airborne route. The precautions include:

- Patient Placement
 - Private room
 - Door closed
 - Room air is exhausted to the outside (Negative air pressure) using fan.
 - If private room not available, place patients in room with patient having active infection with the same disease, but with no other infection
 - The staff on duty should check all visitors for susceptibility before allowing them to visit
- Respiratory Protection
 - Wear surgical mask
 - If chickenpox or measles, no mask needed for immune persons, susceptible persons should not enter the room
 - Remove mask after leaving the room and place in a plastic bag or waste container with tight-fitting lid and reprocess if to be reused

- Patient Transport
 - Limit transport of patient to essential purposes only
 - During transport, patient must wear a surgical mask
 - Notify the area receiving the patient
- In areas where TB is prevalent, it is important to have a mechanism to quickly assess patients with suspected TB and put them under the airborne precautions.

DROPLET PRECAUTIONS

These precautions reduce the risks for nosocomial transmission of pathogens spread wholly or partly by droplets larger than 5 µm in size (e.g., H. influenzae and N. Meningitides, M. pneumoniae, flu, mumps, and rubella viruses). Other conditions include diphtheria, pertussis, pneumonic plague and strep. pharyngitis.

The droplet precautions are simpler than airborne precautions as particles remain in the air for a short time and travel only a few feet.

- Patient placement
 - Private room, door may be left open
 - If private room not available, place patient in room with patient having active infection with the same disease, but with no other infection
 - If neither option is available, maintain separation of at least 3 feet between patients
- Respiratory protection
 - Wear mask if within 3 feet of patient
- Patient transport
 - Limit transport of patient to essential purposes only
 - During transport, patients must wear surgical mask
 - Notify area receiving patients

CONTACT PRECAUTIONS

Contact precautions are indicated for patients infected or colonized with enteric pathogens, herpes simplex and hemorrhagic fever viruses and multidrug resistant bacteria. Chicken pox is spread both by the airborne and contact routes at different stages of illness. Contact precautions should be implemented for patient with wet or draining infection that may be contagious (e.g., draining abscesses, herpes zoster, impetigo, conjunctivitis, scabies, lice and wound infection).

Use in addition to Standard Precautions for patients known or suspected to be infected or colonized with microorganisms transmitted by direct contact with the patient or indirect contact with environmental surfaces or patient care items.

- Patient placement
 - Private room; door may be left open
 - If private room not available, place patient in room with patient having active infection with the same microorganism, but with no other infections
- Gloving
 - Wear clean, nonsterile examination gloves or reprocessed surgical gloves when entering room
 - Change gloves after contact with infectious materials
 - Remove gloves before leaving patient room
- Handwashing
 - Wash hands with antimicrobial agent, or use alcohol handrub, after removing gloves
 - Do not touch potentially contaminated surfaces or items before leaving the room
- Gowns and protective apron
 - Wear clean, nonsterile gown when entering patient room if patient contact is anticipated or patient is incontinent, has diarrhea, an ileostomy, colostomy or wound drainage not contained by dressing
 - Remove gown after leaving room. Do not allow clothing to touch potentially contaminated surfaces or items before leaving the room.
- Patient Transport
 - Limit transport of patient to essential purposes only
 - During transport, ensure precautions are maintained to minimize risk of transmission of organisms
- Patient care equipment
 - Reserve noncritical patient care equipment for use with a single patient if possible, otherwise process as per guidelines
 - Clean and disinfect any equipment shared among infected and non-infected patients after each use

EMPIRIC USE OF TRANSMISSION-BASED PRECAUTIONS

- If there is any question of an infectious process in a patient without a known diagnosis, implementing Transmission-Based Precautions should be considered based on the patient's signs and symptoms until a definitive diagnosis is made.
- A complete listing of clinical syndromes or conditions warranting the empiric use of Transmission-Based Precautions is presented in **Table 15-1**.

Table 15-1. Clinical Syndromes or Conditions to Be Considered for “Empiric Use” of Transmission-Based Precautions

CLINICAL SYNDROME OR CONDITION ^a	POTENTIAL PATHOGENS ^b	EMPIRIC PRECAUTIONS
Diarrhea Acute diarrhea with a likely infectious cause in an incontinent or diapered patient Diarrhea in an adult with a history of recent antibiotic use	Enteric pathogens ^c <i>Clostridium difficile</i>	Contact Contact
Meningitis	<i>Neisseria meningitidis</i>	Droplet
Rash or exanthems, generalized, etiology unknown Petechial/ecchymotic with fever Vesicular Maculopapular with coryza and fever	<i>Neisseria meningitidis</i> <i>Varicella</i> (chicken pox) Rubeola (measles)	Droplet Airborne and Contact Airborne
Respiratory infections Cough/fever/upper lobe pulmonary infiltrate in an HIV-negative patient or a patient at low risk for HIV infection Cough/fever/pulmonary infiltrate in any lung location in an HIV-infected patient or a patient at high risk for HIV infection Paroxysmal or severe persistent cough during periods of pertussis activity Respiratory infections, particularly bronchiolitis and croup, in infants and young children	<i>Mycobacterium tuberculosis</i> <i>Mycobacterium tuberculosis</i> <i>Bordetella pertussis</i> Respiratory syncytial or parainfluenza virus	Airborne Airborne Droplet Contact
Risk of multidrug-resistant microorganisms History of infection or colonization with multidrug-resistant organisms ^d Skin, wound or urinary tract infection in a patient with a recent hospital or nursing home stay in a facility where multidrug-resistant organisms are prevalent	Resistant bacteria ^d Resistant bacteria ^d	Contact Contact
Skin or wound infection	<i>Staphylococcus aureus</i> , group A streptococcus	Contact
<p>^a Patients with the syndromes or conditions listed below may present with atypical signs or symptoms (e.g., pertussis in neonates and adults may not have paroxysmal or severe cough). The clinician’s index of suspicion should be guided by the prevalence of specific conditions in the community, as well as clinical judgment.</p> <p>^b The organisms listed under the column “Potential Pathogens” are not intended to represent the complete, or even most likely, diagnoses, but rather possible etiologic agents that require additional precautions beyond Standard Precautions until they can be ruled out.</p> <p>^c These pathogens include enterohemorrhagic <i>Escherichia coli</i> O157:H7, <i>Shigella</i>, hepatitis A and rotavirus.</p> <p>^d Resistant bacteria judged by the infection control program, based on current state, regional or national recommendations, to be of special clinical or epidemiological significance.</p> <p><i>Adapted from:</i> Garner and HICPAC 1996.</p>		

To assist health workers in correctly implementing the appropriate precautions, **Table 15-2** provides summary of the types of isolation precautions and the illnesses for which each type of precaution is recommended.

Table 15-2. Summary of Types of Precautions and Patients Requiring the Precautions

<p>Standard Precautions Use Standard Precautions for the care of all patients.</p>
<p>Airborne Precautions In addition to Standard Precautions, use Airborne Precautions for patients known or suspected to have serious illnesses transmitted by airborne droplet nuclei. Examples of such illnesses include:</p> <ul style="list-style-type: none"> Measles Varicella (including disseminated zoster)^a Tuberculosis^b
<p>Droplet Precautions In addition to Standard Precautions, use Droplet Precautions for patients known or suspected to have serious illnesses transmitted by large particle droplets. Examples of such illnesses include:</p> <ul style="list-style-type: none"> Invasive <i>Haemophilus influenzae</i> type b disease, including meningitis, pneumonia, epiglottitis and sepsis Invasive <i>Neisseria meningitidis</i> disease, including meningitis, pneumonia and sepsis Other serious bacterial respiratory infections spread by droplet transmission, including: <ul style="list-style-type: none"> Diphtheria (pharyngeal) Mycoplasma pneumonia Pertussis Pneumonic plague Streptococcal (group A) pharyngitis, pneumonia, or scarlet fever in infants and young children <p>Serious viral infections spread by droplet transmission, including:</p> <ul style="list-style-type: none"> Adenovirus^a Influenza Mumps Parvovirus B19 Rubella
<p>Contact Precautions In addition to Standard Precautions, use Contact Precautions for patients known or suspected to have serious illnesses easily transmitted by direct patient contact or by contact with items in the patient's environment. Examples of such illnesses include:</p> <ul style="list-style-type: none"> Gastrointestinal, respiratory, skin or wound infections or colonization with multidrug-resistant bacteria judged by the infection control program, based on current state, regional or national recommendations, to be of special clinical and epidemiologic significance. Enteric infections with a low infectious dose or prolonged environmental survival, including: <ul style="list-style-type: none"> <i>Clostridium difficile</i> For diapered or incontinent patients: enterohemorrhagic <i>Escherichia coli</i> O157:H7, <i>Shigella</i>, hepatitis A or rotavirus Respiratory syncytial virus, parainfluenza virus or enteroviral infections in infants and young children Skin infections that are highly contagious or that may occur on dry skin, including: <ul style="list-style-type: none"> Diphtheria (cutaneous) Herpes simplex virus (neonatal or mucocutaneous) Impetigo Major (noncontained) abscesses, cellulitis or decubiti Pediculosis Scabies Staphylococcal furunculosis in infants and young children Zoster (disseminated or in the immunocompromised host)^a Viral/hemorrhagic conjunctivitis Viral hemorrhagic infections (Ebola, Lassa, or Marburg)
<p>^a Certain infections require more than one type of precaution. ^b See CDC "Guidelines for Preventing the Transmission of Tuberculosis in Healthcare Facilities."</p> <p><i>Adapted from: Garner and HICPAC 1996.</i></p>

REFERENCE

Ducel G. 1995. Les nouveaux risques infectieux. *Futuribles*: 203: 5–32.

PREVENTING NOSOCOMIAL INFECTIONS

Nosocomial (hospital acquired) infections are widespread. They are important contributors to morbidity and mortality. They will become even more important as public health problems with increasing economic and human impact because of increasing number and over crowding of people, more frequent impaired immunity (age, illness and treatments), new microorganisms and increasing bacterial resistance to antibiotics.

The most important nosocomial infections that can be prevented include:

- Urinary tract infections, pneumonia and diarrhea
- Infections following surgery or invasive medical procedures
- Maternal and newborn infections

Most of the nosocomial infections mentioned above can be prevented with readily available, relatively inexpensive strategies by:

- Adhering to infection preventions practices, especially hand hygiene and wearing gloves as recommended in these guidelines
- Paying attention to well-established processes for decontamination and cleaning of soiled instruments and other items, followed by either sterilization or high-level disinfection; and
- Improving safety in operating rooms and other high-risk areas where the most serious and frequent injuries and exposures to infectious agents occur.

Unfortunately, not all nosocomial infections are preventable. For example, some reflect the influence of advanced age, chronic disease such as uncontrolled diabetes, end-stage kidney disease or advanced pulmonary emphysema, severe malnutrition, treatment with certain drugs that lower immunity, and increasing impact of AIDS.

PREVENTING NOSOCOMIAL URINARY TRACT INFECTIONS

Placement of an indwelling catheter should be performed only when other methods of emptying the bladder are not effective. The accepted indications for catheterization are:

- For short-term management of incontinence or retention not helped by other methods
- To measure urine output over several days in critically ill patients
- To instill medications
- For treatment of urinary outlet obstruction
- For postoperative management of surgical patients with impaired bladder function

Indwelling catheters should not be used for the long-term management of incontinence. Other methods of management of urinary tract problems include:

- Intermittent catheterization using a reusable “red rubber” straight catheter
- Condom catheter for male patients
- Adult diaper pads
- Bladder retraining
- Use of drugs to stimulate urination (e.g., carbacol)

GUIDELINES FOR INFECTION PREVENTION DURING INSERTION, REMOVAL AND/OR REPLACEMENT OF URINARY CATHETER

Before inserting a catheter, check to be sure that it is being inserted for the right reason.

During Insertion

1. Make sure that all of the items required to perform the procedure are available:
 - Sterile catheter with close continuous drainage system or HLD or sterile straight catheter and clean urine collection container
 - HLD or sterile syringe filled with boiled or sterile water for blowing up the balloon of an indwelling catheter
 - HLD or Sterile surgical gloves, antiseptic solution, sponge forceps with gauze squares or large cotton applicators, single-use packet of lubricant, light source if needed, basin of clean warm water, soap, a face cloth and a clean dry towel, plastic bag or leakproof, covered waste container
2. Prior to starting the procedure have patient wash the urethral area, if that is not possible wash the area with soap and water.
3. Wash hands with soap and clean water and dry with a clean dry towel or air dry (Alternatively, alcohol handrub can be used if hands are not visibly soiled).
4. Put sterile or HLD gloves on both hands.
5. Prep the urethral area two times with an antiseptic solution using either cotton applicators or a sponge forceps with gauze squares.
6. Avoid touching the tip of the catheter during the procedure.
7. Appropriately dispose all the waste materials including the catheter.
8. If reusing the catheter, place it in a 0.5% chlorine solution for 10 minutes for decontamination.
9. Remove gloves and dispose appropriately.
10. Wash hands or use an antiseptic handrub as appropriate.

During Removal and/or Replacement

1. Make sure that all items as mentioned above are available.
2. Have the patient wash the urethral area or do it for them wearing a pair of clean examination gloves.
3. Wash hands or use an antiseptic handrub.
4. Put clean examination gloves on both hands.
5. Prep the urethral area two times with an antiseptic solution.
6. If you are replacing the indwelling catheter follow appropriate IP steps as mentioned above under the Insertion Procedure.

Tips for Preventing Infections in Catheterized Patients

- Remove the catheter as soon as possible.
- The catheter collection system should remain closed and not be opened unless absolutely necessary for diagnostic or therapeutic reasons.
- Caution the patient against pulling on the catheter.
- Urine flow through the catheter should be checked several times a day.
- Avoid raising the collection bag above the level of the bladder.
- If it becomes necessary to raise the bag above the level of the patient's bladder during transfer of the patient to a bed or stretcher, clamp the tubing.
- Before the patient stands up, drain all urine from the tubing into the bag.
- The urine drainage (collection) bags should be emptied aseptically; touching the tip of the emptying tube to the side of the collection bag or permitting the tip to touch the urine in the vessel should be avoided. Replace bags with new or clean containers when needed.
- If the drainage tubing becomes disconnected, do not touch the ends of the catheter or tubing. Wipe the ends of the catheter and tubing with an antiseptic solution before reconnecting them.
- Wash the head of the penis and urethral opening (men) or the tissue around the urethral opening (women) after a bowel movement or if the patient is incontinent.
- If frequent irrigation is required, the catheter should be changed.

There is no evidence that daily perineal care reduces the risk of catheter associated Urinary Tract Infections.

What Does Not Work

- Continuous irrigation of the bladder with antibiotics does not prevent UTIs and is associated with increased risk of resistant organisms
- The role of prophylactic antibiotics has not been established in preventing UTIs among catheterized patients
- Applying antiseptic or topical antibiotics to the urethral area does not reduce the risk of catheter associated UTIs

PREVENTING SURGICAL SITE INFECTIONS (SSIS)

To reduce the risk of nosocomial SSIs, a systematic but realistic approach must be applied with awareness that this risk is influenced by characteristics of the patient, the operation, the healthcare staff and the hospital.

The surgical wound classification system includes four categories, clean, clean-contaminated, contaminated and dirty or infected.

Reducing the Risk of Surgical Site Infections

The risk of surgical site infection can be greatly reduced if each member of the team follow the steps described below, before, during and after surgical procedure.

Preoperative

1. Preparation of the patient

- Whenever possible, identify and treat all infections remote to the surgical site before an elective operation and postpone elective operations on patients with remote site infections until the infection has resolved.
- Do not remove hair preoperatively unless the hair at or around the incision site will interfere with the operation.
- If hair is removed, remove immediately before the operation, preferably with a pair of scissors.
- Adequately control serum blood glucose levels in all diabetic patients.
- Encourage stopping use of tobacco products at least 30 days prior to elective operation.
- Do not withhold any blood products from surgical patients as a mean to prevent SSI.
- Instruct patients to shower with soap and water or an antiseptic agent on at least the night before the operation day.
- Thoroughly wash and clean at and around the incision site to remove gross contamination before performing antiseptic skin preparation.
- Prep the skin using concentric circles moving toward periphery.
- Keep preoperative hospital stay as short as possible.

2. Hand/forearm antisepsis for surgical team members

- Keep nails short and do not wear artificial nails.
- Perform a preoperative surgical scrub for at least 2–5 minutes using an appropriate antiseptic. Scrub up to elbows. Do not use brush for scrubbing.
- After performing the surgical scrub, keep hands up and away from the body so that water runs from the tips of the fingers toward the elbows. Dry hands with a sterile towel and put on a sterile gown and gloves.
- Clean underneath each fingernail prior to performing first surgical scrub of the day.
- Do not wear hand or arm jewelry.

3. Management of infected or colonized surgical personnel

- Surgical personnel with signs and symptoms of a transmissible infectious disease (e.g., running nose, fever, malaise) should promptly report to their supervisors.
- Personnel having potentially transmissible infectious conditions (e.g., infected skin lesions) should not be allowed to work in the operating rooms.
- Do not routinely exclude surgical personnel who are colonized with organism such as *S. aureus* or Group A *Streptococcus*, unless such personnel have been linked epidemiologically to dissemination of the organism in the healthcare setting.

4. Antimicrobial prophylaxis

- Administer a prophylactic antimicrobial agent only when indicated, and select it based on its efficacy against most common pathogens causing SSI for a specific operation.
- Administer by the IV route the initial dose of antibiotic, timed such that a bactericidal concentration of the drug is established in serum and tissues when the incision is made. Maintain therapeutic levels of the agent in serum and tissues throughout the operation and until, at most, a few hours after the incision is closed in the operating room.
- Before elective colorectal operations in addition to above, mechanically prepare the colon by use of enemas and cathartic agent.
- For high-risk cesarean section, administer the prophylactic antibiotic immediately after the umbilical cord is clamped.

Intraoperative

1. Ventilation in operating room

- Let the air enter at the ceiling, and exhaust near the floor.
- If available, use positive pressure ventilation in the operating rooms.
- Do not use UV (Ultra Violet) radiation in the operating room to prevent SSI.
- Keep operating room doors closed except as needed for passage of equipment, personnel and the patient.
- Limit number of personnel entering the operating room to necessary personnel.

2. Cleaning and disinfection of environmental surfaces

- Use disinfectant to clean the surfaces visibly soiled with blood or body fluids before the next operations.
- Do not perform special cleaning or closing of operating rooms after contaminated or dirty operations.
- Do not use tacky mats at the entrance to the operating room suite or individual operating rooms for infection prevention.

3. Microbiologic sampling

- Do not perform routine environmental sampling of the operating room unless as a part of epidemiological investigation.

4. Sterilization of surgical instruments

- Sterilize all surgical instrument according to the guidelines discuss in chapter on instrument processing.

5. Surgical attire and drapes

- Wear mask and cap to fully cover the face and hair before entering the operating room. Wear them throughout the operation.
- Do not wear shoe covers to prevent SSIs.
- Use surgical gowns and drapes that are effective barriers.
- Change scrub suite that are visibly soiled, contaminated and/or penetrated by blood or other potentially infectious materials.

6. Asepsis and surgical technique

- Adhere to principles of asepsis when placing IV device, spinal or epidural anesthesia, or when dispensing and administering IV medication.
- Assemble sterile equipment and solutions immediately prior to use.
- Handle tissue gently, maintain effective hemostasis, minimize devitalized tissue and foreign bodies and eradicate dead space at the surgical site.
- Use delayed primary skin closure or leave an incision open to heal by second intention if the surgeon considers the surgical site to be heavily contaminated.
- If drainage is necessary, use a closed suction drain. Place a drain through a separate incision distant from the operative incision. Remove drain as soon as possible.

Postoperative Incision Care

1. Protect surgical incision with a sterile dressing for 24 to 48 hours postoperatively and incision that has been closed primarily.
2. Wash hands before and after dressing and any contact with the surgical site.
3. When an incision dressing must be changed, use sterile technique. Healthy tissue growth is damaged when the dry gauze is removed; therefore, moisten the dry gauze with sterile normal saline before removing/changing the dressing.
4. Educate patients and families regarding proper incision care, symptoms of SSI, and the need to report such symptoms.
5. No recommendations to cover an incision closed primarily beyond 48 hours, nor on the appropriate time to shower or bathe with an uncovered incision.

Putting topical antibiotic ointment on closed skin incisions does not decrease the risk of SSIs.

The guidelines for choosing a prophylactic antibiotic for prevention of wound infection and sepsis in surgical patients and for preventing bacterial endocarditis in patients with previous endocarditis, prosthetic heart valves, and complex congenital heart disease are given on the next page.

PREVENTING INFECTIONS RELATED TO USE OF INTRAVASCULAR DEVICES

The use of intravascular devices, both venous and arterial, has dramatically increased during the past decade. Because catheters inserted into the venous or arterial bloodstream bypass the normal skin defense mechanism, these devices provide a way for microorganisms to enter the bloodstream

from: the device at the time of insertion, subsequent contamination of the device or attachments or pathogens on the skin surrounding the insertion site.

Infection Prevention Practices for Insertion, Maintenance and Removal of Peripheral Venous Lines

Nosocomial infection could occur anytime while:

- Establishing an IV line
- IV Line is in position
- Changing the IV solution and changing IV tubing and
- Removing IV line
- Administering blood or blood products

The risk of nosocomial infections can be greatly reduced by using proper infection preventions practices and proper monitoring of patient. These practices include:

- Making sure all items required for performing a procedure are available
- Preparing skin at the site of venipuncture following the guidelines on preparing the skin
- Washing hands with soap and clean water or using alcohol handrub if hands are not visibly soiled
- Following aseptic technique while handling the infusion set and assembling the parts
- Putting on clean examination gloves or reprocessed surgical gloves before puncturing a vein
- Properly securing the needle or catheter and covering venipuncture site using clean square gauze and surgical tapes

Note: Applying antimicrobial ointment around the insertion site does not reduce the risk of infection.

- Changing dressing every 72 hours or whenever it is wet, soiled or loose
- Disposing of all contaminated wastes including gloves following the waste disposal guidelines
- Monitoring patient on hourly basis (depending upon patient's condition) to determine her/his response to the fluid therapy and checking that, IV line is open and running
- Checking every 8–12 hours for phlebitis or evidence of infection
- Rotating infusion site every 72–96 hours, when practical
- Changing infusion set whenever they are damaged and at 72 hours routinely
- Avoiding direct contact with the spikes while changing IV solution
- Changing IV tubing every 24 hours if used to administer blood, blood product or lipid emulsion, or 96 hours for other fluids
- Avoiding direct contact with any area of the tubing that will come in contact with IV fluid or blood

- Covering the venipuncture site with dry gauze square when site is changed and new line is established
- Covering the venipuncture site with dry gauze square or sterile bandage after removing the IV line

PREVENTING MATERNAL AND NEWBORN INFECTIONS

The following prevention efforts are being recommended to successfully reduce the risk of fetal and newborn infections:

- Maternal immunization (Tetanus Toxoid)
- Antenatal treatment of maternal syphilis, gonorrhea and Chlamydia infections.
- Prophylactic use of postnatal eye drops to prevent chlamydia, gonorrhea and candida eye infections
- Prophylactic treatment of pregnant women at risk of group B streptococcal disease and
- Maternal and newborn treatment with antiretroviral to prevent mother-to-child transmission of HIV.

Infection Prevention Guidelines for Reducing the Risk of Maternal and Newborn Infections

Minimizing the Risk of Infection during Labor and Vaginal Delivery

Although vaginal deliveries do not require the aseptic conditions of an operating room, a few simple practices can make the procedure safer for the mother, the infant and the healthcare providers. For example keeping hands, perineal area and newborn's umbilical area clean during and following childbirth, and having clean delivery kits help improve the safety of home births for both mother and newborn.

Prolonged ruptured membranes, trauma to the birth canal, manual removal of placenta, episiotomy, and midcavity forceps delivery increase the risk of endometritis and UTI.

To minimize this risk:

- Use a pair of clean examination gloves, or HLD surgical gloves, for each vaginal examination during delivery (Sterile gloves are not necessary for vaginal examination)
- Keep number of vaginal examination during labor to minimum possible (1st vaginal examination at admission. Followed by repeat examination every four hours, unless indicated otherwise)
- Avoid pushing the tip of the examination finger up against the opening to the cervix until active labor occurs or until the decision has been made to induce labor
- Carefully limit cases for student training to those patients in active and progressive labor

Vaginal Delivery

Steps that can be taken to decrease the risk of maternal infection before and during delivery:

Before Delivery

1. Make sure all supplies are available for proper infection prevention:
 - Examination gloves
 - HLD or sterile surgical gloves
 - Elbow-length gloves—readymade or prepared in clinic
 - PPE—mask, apron, faceshield or goggles
 - Basin of clean warm water
 - Soap
 - Waterless antiseptic handrub
 - HLD or sterile instruments including sterile cord clamp
 - Cotton thread
 - Clean basin for placenta
 - Clean drape for wrapping the newborn
 - Sharp container
 - Leakproof covered waste container
 - Bucket with 0.5% chlorine solution
 - Gauze squares
 - Enough quantity of disposable syringes and needles
2. Make sure all instruments required for assisting conducting delivery are available (sterile delivery set, episiotomy set, and necessary medications)
3. With examination gloves on wash the perineal area of the woman with soap and clean water. Use a downward and backward motion when washing the perineal area so that fecal organisms will not be introduced into the vagina. Clean the anal area last and place the washcloth or towel in a plastic container.
4. Do not shave the perineal hair. If required trim them using a pair of scissors.
5. Immerse both gloved hands in 0.5% chlorine solution, remove gloves by inverting and place them in the plastic bad or a leakproof covered container.
6. Thoroughly wash hand with soap and water and dry using towel or air dry.
7. Apply 5 ml of the antiseptic handrub to hand and forearms and rub vigorously until dry. Repeat application 2 more times or at least for 2 minutes.
8. Put HLD or sterile surgical gloves on both hands.
9. Wear protective equipment including plastic apron and face shield (or a mask and goggles and plastic shoes).

During Delivery

- For resuscitation of the newborn, use mechanical suction if available. For mouth suction, place a trap in the line.
- If manual removal of the placenta is required, use elbow length gloves or fingerless surgical gloves.

After Delivery

1. Before removing the gloves, put the placenta in the clean basin and place all waste items in the plastic bag or leakproof, covered waste container
2. If an episiotomy was done or there were vaginal or perineal tears requiring surgical repair, place sharps in the puncture-resistant sharp container, dispose of single use hypodermic needle and syringes by flushing three times with 0.5% chlorine solution before putting in a puncture-resistant container. If reusing, fill syringes with needle attached with 0.5% chlorine solution and soak for 10 minutes.
3. Immerse both gloved hands in a 0.5% chlorine solution; remove by inverting, and place in the plastic bag or leakproof, covered waste container for discarding. If reusing, place them in a 0.5% chlorine solution for 10 minutes.
4. Wash hands or use an antiseptic handrub.

Infection Prevention Guidelines for Minimizing the Risk of Infection during Cesarean Section

- The surgical team should use proper personal protective equipment.
- Double gloving should be used as per the national guidelines.
- Appropriate antibiotic prophylaxis should be given IV after the cord is clamped if the risk of infection is high.
- With prolonged ruptured membranes or with documented chorioamnionitis, avoid spillage of amniotic fluid into the abdominal cavity, place folded, moistened sterile laparotomy pads on either sides of the uterus to catch as much contaminated fluid as possible, If large amounts of meconium or amniotic fluid spills into the abdominal cavity, remove the laparotomy pads and lavage the cavity with sterile isotonic saline solution. Do not explore the peritoneal cavity unless absolutely necessary, and then only after closure of the uterine incision and surgical gloves have been changed.
- If the cervix is closed and membranes were not ruptured prior to the surgery, dilate the cervix through the vagina sufficiently to permit the outflow of blood and fluid after delivering the baby and placenta, insert gloved finger into the cervix only once to dilate it, do not go back and forth or remove the hand from the pelvis and then put the finger back into cervix, when dilatation is completed, remove the gloves and put on a new pair of sterile or HLD surgical gloves.
- The health worker receiving the infant should wash hands and put on clean examination gloves before handling the baby.
- The baby should be placed on a clean towel after being passed off to the health worker caring for the infant.
- To minimize the postoperative wound infection, patients should not be shaved prior to surgery, make skin incision with a scalpel rather than cautery, after the fascia is closed, irrigate the wound with sterile isotonic saline and then blot it dry, do not place drains in the subcutaneous layer, close the skin edges using a subcuticular technique and apply a sterile dressing and care for the wound as described elsewhere in these guidelines.

Postpartum Care of the Woman

- Wear examination or utility gloves when handling perineal pads, touching lochia or touching the episiotomy.
- Teach the woman how to wash the perineal area with clean warm water after changing a pad or having bowel movement.
- If the woman is breastfeeding, teach her how to care for her breasts and nipples to avoid infection. Also teach woman how to put baby to the breasts.
- After cesarean delivery, to avoid pulmonary problems during the immediate postoperative period and for the next few days, use anti pain medicine cautiously, encourage woman to move about in bed and take deep breaths frequently, and get her out of bed and walking within the first 12 hours.
- If indwelling catheter was inserted, check to be sure urine is flowing and the urine collection system is intact, follow the “Tips for Preventing Infections” as described under prevention of urinary tract infections and remove catheter as soon as possible (within 24 hours).

Care of the Newborn

- Wash hands before holding or caring for the infant.
- Wear gloves and plastic apron when handling the newborn until blood, meconium or amniotic fluid has been removed from the infant’s skin.
- Carefully remove blood and other body fluid using a cotton cloth, not gauze, soaked in warm water followed by drying the skin.
- Bathing or washing the newborn should be delayed until the baby’s temperature is stabilized. The buttocks and perineal areas are the most important to keep clean. They should be washed after changing diaper using a cotton clothe soaked in warm soapy water, and then carefully dried.
- Wash hands, or use an antiseptic handrub, before and after cord care.
- Keep cord stump clean and dry.
- Do not cover the cord stump with a dressing or bandage.
- Fold the diaper below the cord stump.
- If the cord stump gets soiled or dirty, gently was it with warm (preferably boiled) clean soapy water, and rinse with warm (preferably boiled) clean water.

Preventing Specific Infection of Fetus and Newborn

- **Group B Streptococcal Septicemia:** Providing prophylactic antibiotics against Group B Streptococcal Septicemia to women having any one of the risk factors including, group B streptococci bacteriuria during pregnancy, previously delivered infant infected with group B streptococcal infection, preterm birth, rupture of membranes (>18 hours) and clinically evident chorioamnionitis with maternal temperature greater than 38°C or prior infected child. Prophylactic antibiotics should be given as soon as labor starts or a risk factor is identified. Recommended treatments include Penicillin G 5 million units IV loading dose followed by 2.5 million units every four hours until delivery. Alternative regimens include, Ampicillin 2 g IV

loading does and then 1 g IV every 4 hours until delivery or Erythromycin 500 mg. IV every six hours until delivery.

- **Chlamydial Infection:** In absence of antenatal testing for mothers, prophylactic eye drops is the only preventive measure to prevent chlamydial conjunctivitis. However, it will not prevent pneumonia which is mild and easily and inexpensively treated following standard precautions and appropriate transmission based precautions
- **Gonorrheal Infection:** Prevention during pregnancy includes treatment of infected women with Erythromycin or other appropriate antibiotics. In the absence of antenatal testing, prophylactic eye drops (tetracycline or erythromycin) is the only preventive measure usually available. Follow the National STI Management Guidelines for managing all STIs including Gonorrhea.
- **Neonatal Tetanus:** Can be prevented by immunizing all women of childbearing age, especially pregnant women (at the minimum two doses of tetanus toxoid prior to delivery 4 weeks apart), improving the quality and availability of maternity care and educating mothers, relatives and birth attendants of the need for cutting the cord with a clean instrument and keeping the cord stump clean and dry.
- **Syphilis Antenatal:** Testing of pregnant women is routinely done in Ethiopia. If the results of serologic tests are positive, woman should receive treatment for syphilis according to the National STI Management Guidelines
- **Hepatitis B:** Ideally all pregnant women should be immunized for Hepatitis B. If HBV is endemic all infants should receive HBV vaccine within 12 hours.
- **Hepatitis C:** There is no vaccine for HCV and so primary prevention, including education combined with behavior change interventions aimed at promoting safe sexual practices, is the only option.
- **Herpes Simplex Virus:** Where possible, pregnant women at term with documented genital lesions and intact membranes should be delivered by cesarean section, however, this may not be possible at most places with limited resources. Standard precautions and transmission-based precautions should be used to minimize the risk of transmission to other newborn and health workers. Mothers with active lesions should be placed on transmission-based precautions until discharge. Mother should cover nongenital lesions and thoroughly wash and dry her hands before touching the baby. She should cover her upper body with a clean cloth or gown so that the baby does not come in contact with lesions. If the woman has lesions on her lips, or blisters or face, she should not cuddle or kiss her baby until the lesions are healed. Use of a mask is recommended. Breastfeeding can be done provided there are no lesions in the breast area and all skin lesions are covered. Direct contact of a newborn with other family members or friends who have active HSV should be avoided
- **HIV:** Please refer to National PMTCT guidelines published by MOH, Ethiopia for prevention of HIV infection to newborn.
- **Human Papilloma Virus:** Infants born to mothers infected with genital HPV do not need special precautions. Cesarean section may be necessary, however, in women whose genital warts are so extensive that soft tissue stretching of the vulva and perineum may not be sufficient to allow vaginal delivery.
- **Rubella:** Newborns lacking passively acquired maternal antibodies may develop congenital rubella infection if exposed to the virus during pregnancy. Vaccination of all children and nonpregnant women is the most effective method of preventing congenital rubella in infants.

Newborns with congenital rubella infection, or those born to mothers known to have had rubella during pregnancy, should not be kept with other newborns. Pregnant women with active rubella at the time of admission to the hospital should labor and give birth in a separate area.

- **Varicella (Chicken Pox):** Newborns lacking passively acquired maternal antibodies may develop a life-threatening infection if exposed to the virus within the last two weeks of pregnancy or at the time of delivery. The greatest risk is if the baby is born within 2–5 days after the onset of maternal chicken pox. If available, infants at risk should receive varicella immune globulin, 1.25 ml IM. Standard precautions and Transmission-based Precautions should be followed for these newborns. Pregnant women with active varicella at the time of admission to the hospital should labor and give birth in a separate area. Where possible, care should be provided to the mother only by health workers known to have had varicella or those previously vaccinated.

REFERENCES

- American Academy of Pediatrics (AAP) and American Academy of Obstetricians and Gynecologists (ACOG). 1997. *Guidelines for Perinatal Care*, 4th ed, revised. AAP: Elk Grove, IL.
- Association for Professionals in Infection Control and Epidemiology (APIC). 2002. Intravascular device infections, in *APIC Text of Infection Control and Epidemiology*, revised ed. APIC: Washington, DC, pp 30-1 to 30-8.
- Burke JP and D Zavasky. 1999. Nosocomial urinary tract infections, in *Hospital Epidemiology and Infection Control*, 2nd ed. Mayhall CG (ed). Lippincott, Williams and Wilkins: Philadelphia, pp 173–187.
- Burke JP, RA Larsen and LE Stevens. 1986. Nosocomial bacteriuria—estimating the potential for prevention by closed sterile drainage systems. *Infect Control* 7(Suppl 2): 96–99
- Centers for Disease Control and Prevention (CDC) and Hospital Infection Control Practices Advisory Committee (HICPAC). 1996. Guidelines for prevention of intravascular device-related infections. *Infect Control Hosp Epidemiol* 17(7): 438–473. (Authors: Pearson ML and HICPAC).
- Conover W and TR Moore. 1984. Comparison of irrigation and intravenous antibiotic prophylaxis at cesarean section. *Obstet Gynecol* 63(6): 787–791.
- Cunningham FG et al. 1983. Perioperative antimicrobials for cesarean delivery: Before or after cord clamping? *Obstet Gynecol* 62(2): 151–154.
- Hemsell DL. 1991. Prophylactic antibiotics in gynecologic and obstetric surgery. *Rev Infect Dis* 13(Suppl 10): S821–S841.
- Horan TC et al. 1992. CDC definitions of nosocomial surgical site infections, 1992: A modification of CDC definitions of surgical wound infections. *Infect Control Hosp Epidemiol* 13(10): 606–608.
- Iffy L et al. 1984. Infection control in obstetrics, in *Operative Perinatology: Invasive Obstetric Techniques*. Iffy L and C Charles (eds). Macmillan: New York, pp 86–99.
- Landry K and D Kilpatrick. 1997. Why shave a mother before she gives birth? *Matern Child Nurs* 2: 189–190.
- Maki DG. 1992. Infections due to infusion therapy, in *Hospital Infections*, 3rd ed. JV Bennett and PS Brachman (eds). Little, Brown and Company: Boston, pp 849–898.
- Maki DG, M Ringer and CJ Alvarado. 1991. Prospective, randomized trial of povidone-iodine, alcohol and chlorhexidine for prevention of infection associated with central venous and arterial catheters. *Lancet* 338(8763): 339–343.
- Mayhall CG. 1992. Diagnosis and management of infections of implantable devices used for prolonged venous access. *Curr Clin Top Infect Dis* 12: 83–110.

The Medical Letter. 2001. Antimicrobial prophylaxis in surgery. *The Medical Letter* 43: 1116–1117.

SHEA, APIC, CDC and SIS. 1990. Consensus paper on the surveillance of surgical wound infections. *Infect Control Hosp Epidemiol* 18(5): 599–605.

Warren JW. 2000. Nosocomial urinary tract infections, in *Principles and Practices of Infectious Diseases*, 5th ed. Mandell JE et al (eds). Churchill Livingstone, Inc.: Philadelphia, pp 328–339.

Warren JW et al. 1978. Antibiotic irrigation and catheter-associated urinary tract infections. *N Engl J Med* 299(11): 570–573.

PREVENTING INFECTIOUS DIARRHEA AND MANAGING FOOD AND WATER SERVICES

Outbreaks of diarrhea in various patient care areas of hospitals have been associated with a wide variety of organisms including salmonella, shigella, *C. difficile*, cholera, *C. albicans*, *Staph. aureus*, cryptosporidium, rotavirus and other enteroviruses.

GUIDELINES FOR REDUCING THE RISK OF NOSOCOMIAL DIARRHEA

- **Hand cleanliness and gloves:** Patients and staff should perform hand hygiene after contact with fecal organisms in bathrooms; on toilet articles such as bedpans, or on patients who have fecal incontinence. Wear new, clean examination gloves before touching mucous membranes of all patients, including infants and children and utility gloves should be worn if activities are likely to involve touching or handling feces.
- **Environmental contamination and soiled linen:** Clean bedpans and bathroom equipment that are regularly handled by patients and staff with a disinfectant daily and whenever they have been used. All soiled articles should be immediately cleaned and disinfected. Guidelines for processing linen should be meticulously followed.
- **Food services personnel:** Food handlers with diarrhea should be immediately removed from handling foods. They should not return to food handling or work with immunocompromised patients or intensive care or transplant patients until all symptoms are over for 24–48 hours.
- **Patients with diarrhea:** These patients should be managed according to Standard Precautions with Transmission-Based Precautions added if the diagnosis indicates. Infants born to mothers with diarrhea should not enter the regular wards. Rather, rooming-in should be provided for mother and infant, and the mother should be taught good hygiene.
- **Outbreak management:** The successful management of outbreaks of diarrhea related to common source contamination in healthcare facilities usually requires, finding the common source and eliminating it, grouping patients with diarrhea together and not allowing the sharing of equipment or staff with any new or uninfected patients, discharging affected and unaffected patients early if they can be managed at home, making sure that housekeeping is thorough and frequently performed, and providing separate space and extra staff to care for affected infants in neonatal wards.

Managing Food and Water Services

Factors that increase risk of nosocomial diarrhea in healthcare facilities include the fact that they serve food for more hours, serve ill and immunocompromised patients, transporting and distributing food at greater distances, and prepare nasogastric feeding and special diets. In addition, staff often are transient, poorly trained and may have other health problems that can contribute to poor quality food services.

Food Service Guidelines

All activities in the food service department should be monitored regularly to be sure that safety standards are being followed, including:

- **Holding temperatures** should be above 60°C/140°F or below 7°C/45°F. Thermometers for food storage should be checked periodically. Warm, perishable foods should be cooled before being stored.
- **Cooking should be complete.** Frozen food items should be thawed before cooking to avoid the presence of cold spots in the interior.
- **Personal health and hygiene** of food service staff are of great importance and should be supervised by a knowledgeable person. Hand hygiene plays crucial role in preventing nosocomial diarrhea. The staff should report any gastrointestinal problems or skin lesions, especially on hands. They need to know how properly inspect, prepare and store the foods they handle, how to clean and operate equipment they use such as slicers, blenders and dishwashers, if they are available and waste management.
- **Ensure equipment cleaning and disinfection**, especially cutting boards used for preparing raw meat, fish or poultry.
- **Purchase raw food** from known vendors that meet local inspection standards, if possible. Foods prepared at homes should not be shared with other hospitalized patients.

Preparation of Clean Water

Water boiled for 1–5 minutes is considered safe to drink, while water boiled for 20 minutes is high-level disinfected. Alternatively, water can be disinfected and made safe for drinking by adding a small amount of sodium hypochlorite. The formula for preparing 0.001% of chlorine solution is given elsewhere in these guidelines. The preparation of clean water containing up to 0.001% sodium hypochlorite solution is inexpensive, easy to do and often is needed during emergency situation.

REFERENCES

- Levine WC et al. 1991. Foodborne disease outbreaks in nursing homes, 1975–1987. *JAMA* 266(15): 2105–2109.
- Lynch P et al. 1997. Preventing nosocomial gastrointestinal infections, in *Infection Prevention with Limited Resources*. ETNA Communications: Chicago, pp 125–130.
- McFarland LV et al. 1989. Nosocomial acquisition of *Clostridium difficile* infection. *N Engl J Med* 320(4): 204–208.
- Villarino ME et al. 1992. Foodborne disease prevention in healthcare facilities, in *Hospital Infections*, 3rd ed. Bennett JV and PS Bachman (eds). Little, Brown and Company: Boston, pp 345–358.

PREVENTING NOSOCOMIAL PNEUMONIA

GUIDELINES FOR REDUCING THE RISK OF NOSOCOMIAL PNEUMONIA

Preoperative Pulmonary Care

During preoperative period teach patients about to take deep breaths, moving in the bed, frequent coughing, and early movement—sitting up and walking—to prevent postoperative pulmonary problems. Limited use of narcotic analgesics for a short duration can reduce the risk of nosocomial pneumonia.

Preventing Colonization and Infection with New Organisms

Using clean gloves (new examination or reprocessed surgical gloves) prior to contact with the mucous membrane or nonintact skin of patients play significant role in preventing colonization with pathogenic organisms.

Respiratory Therapy Equipment

To minimize cross-contamination when suctioning patients on ventilators:

- Wash hands or use an alcohol-based antiseptic handrub before putting on gloves.
- Wear clean examination gloves, or reused surgical gloves that have been high-level disinfected, and a protective face shield or mask.
- Remove gloves immediately after therapy is completed and discard them in a plastic bag or leakproof, covered waste container.
- Wash hands or use an alcohol-based antiseptic handrub after removing gloves.

Suction catheters should be decontaminated, cleaned and high-level disinfected by boiling or steaming between uses. In addition, use of large containers of saline or other fluids for instillation or rinsing the suction catheter should be avoided. If possible, only small containers of sterile solutions or boiled water, which can be used only once and then replaced, should be used.

To reduce the risk of contamination and possible infection from mechanical respirators and other equipment, the following are suggested:

- Prevent condensed fluid in the ventilator tubing from refluxing into the patient because it contains large numbers of organisms. (Any fluid in the tubing should be drained and discarded, taking care not to allow the fluid to drain towards the patient.)
- Use only small nebulizer bulbs because nebulizers produce aerosols that can penetrate deep into the lungs. (Contaminated large-volume nebulizers have been associated with gram-negative pneumonia and should not be used.)
- Contaminated humidifiers for oxygen administration and ventilator humidifiers are unlikely to cause nosocomial pneumonia because they do not generate aerosols. These humidifiers can,

however, be a source of cross-contamination, so they should be cleaned and disinfected between patients.

- Although ventilator circuits may become contaminated at the patient end by organisms from the respiratory tract, there is little evidence that pneumonia is associated with this contamination. Therefore, it is not necessary to change the circuits.
- Breathing circuits should be decontaminated, cleaned and high-level disinfected by steaming or soaking in a chemical high-level disinfectant.
- Resuscitation devices, such as Ambu bags, are difficult to decontaminate, clean, high-level disinfect and dry between uses. For example, if not thoroughly disinfected and dried, fluids left inside the bag or face piece can be aerosolized during the next use. To prevent this, a good system for prompt reprocessing and return to use is necessary.

Preventing Gastric Reflux

Even short-term (a few days) use of nasal feeding tubes increases the risk of aspiration. Feeding small, frequent amounts rather than large amounts may be less risky. Also, raising the head of the bed, so that the patient is more or less in a sitting position, makes reflux less likely.

Postoperative Care

- Follow proper hand hygiene and gloving procedures.
- If using suction catheters, decontaminate, clean and HLD before use.
- Use only small nebulizer bulbs and one bulb should not be used for more than one patient.
- Limit the use of anti pain medication and nasogastric tubes.
- Help patient move out of the bed as soon as possible.
- Encourage deep breathing in the immediate postoperative period and for the next few days following surgery.

REFERENCES

Centers for Diseases Control and Prevention (CDC). 1994. Guidelines for prevention of nosocomial pneumonia. Part 1. Issues on prevention of nosocomial pneumonia. Part 2. Recommendations for prevention of nosocomial pneumonia. *Am. J Infect Control* 22(4): 247–292. (Authors: Tablan OC et al and HICPAC)

Lynch P et al. 1997. Preventing nosocomial pneumonia, in *Infection Prevention with Limited Resources*. ETNA Communications: Chicago, pp 131–134.

Schaefer SD et al. 1996. Respiratory care, in *Pocket Guide to Infection Prevention and Safe Practice*. Mosby-Year Book, Inc.: St. Louis, MO, pp 363–386.

MANAGEMENT OF INFECTION PREVENTION PROGRAMS

Successful programs for preventing the spread of infectious disease by any route in healthcare facilities are based on understanding the scope of the problem, prioritizing activities and effectively using available resources. Because available resources are invariably limited, careful planning, implementing and monitoring activities on a regular basis, whether in a health post or a busy district/regional hospital, are all essential.

It is the responsibility of administrators and health facility managers, working in conjunction with key staff (the nurses, surgeons and cleaning staff) serving on operating room safety or infection prevention committees (if not already established, form a committee including the staff from regional/zonal/woreda level and assign a focal person), to set standards for performance as per the national guidelines, guide the staff and regularly monitor staff performance and help staff at all levels “buy in” to using common sense when performing their assigned duties, as well as using appropriate personal protective equipment at all times.

The main organizing principles for managing an infection prevention program include:

- Establishing the relative importance of problems using the Spaulding categories of potential infection risk:
 - Critical
 - Semicritical
 - Noncritical
- Identifying and analyzing the reasons for poor or incorrect performance
- Costing the issues

WHO SHOULD BE INVOLVED IN MANAGING THE PROGRAM

The working group should include representatives from a variety of patient care areas including surgery, central sterilization department, housekeeping, laboratory, laundry, kitchen, and administration.

Basic Guidelines and Activities that Help Managers Implement Successful IP Practices

- Use national infection prevention guidelines to handle situations in which patients or staff are exposed to the risk of infection.
- Conduct staff orientation before new policies, recommendations, or procedures are started and provide followup training when management reinforcement is needed.
- Be sure adequate supplies, equipment, and facilities are available before start-up to ensure compliance.

- Conduct regular reviews to ensure the adequacy of the recommended changes or practices, to solve any new problems, and to address staff concerns.

For making management decisions regarding the changes to be made in the current practices, the evidence-based recommendations in these guidelines should be used.

STAFF TRAINING

Initially, all levels of healthcare workers need to know why infection prevention is important. Key topics to be taught should include:

- The disease transmission cycle, routes of infection and how to break the cycle
- Use of standard precautions when dealing with all clients/patients, not just those who appear or are known to be infected
- Methods of minimizing disease transmission as well as “hands on” demonstrations covering, handwashing and using waterless, alcohol-based antiseptic handrub, cleaning up a blood or body fluid spill, giving an injection and disposing of sharps, learning to suture with blunt-tipped needles
- Instrument processing and waste management

To have long-term effects, the initial training should be followed up, and monitoring should be targeted toward identifying and solving specific problems related to introducing the new process or procedure.

General reminders regarding the importance of maintaining an infection-free environment for safer delivery of services also should be repeatedly emphasized.

Monitoring the Effectiveness of Training

Regular monitoring of infection prevention practices and processes is important, not only to assess their effectiveness but also to determine the topics about which staff may need more training or review. To monitor effectiveness:

- Spot check how staff are performing any new procedure
- Assess whether recommended practices are being followed
- Note whether the necessary equipment and supplies are available and being used properly

Based on the findings, future topics for training can be identified.

MONITORING INFECTION PREVENTION PRACTICES

Keeping records of infections that occur in hospitals and clinics is a time-honored way of monitoring the effectiveness of infection prevention practices. In particular, keeping records on postoperative infections can help to identify breaks in recommended infection prevention practices. There should be a staff assigned to keep records or relevant information.

For trouble-shooting questions to consider include:

- Are recommended infection prevention being followed in the operating rooms?
- Is the operative site being cleaned preoperatively, especially when it is visibly soiled?
- Is an approved antiseptic at the correct concentration being used to prepare the operative site?
- Do any members of the surgical team have long fingernails?
- Are surgical gloves being reused?
- Are the infections linked to any particular surgical team or person?
- Are instruments and equipment being thoroughly cleaned prior to sterilization or high-level disinfection?
- Is the sterilizer working correctly?
- Is sterilization or high-level disinfection being timed correctly?

If the answer to any of these questions is “no”, further information about the identified areas should be collected and the problems identified before deciding whether training, better equipment or management reinforcement is the corrective action needed.

REFERENCES

Lynch P et al. 1997. *Infection Prevention with Limited Resources*. ETNA Communications: Chicago, pp 2–9.

Seto WH et al. 1990. Brief report: The utilization of influencing tactics for the implementation of infection control policies. *Infect Control Hosp Epidemiol* 11(3): 144–150.



INFECTION-MONITORING (SURVEILLANCE) ACTIVITIES

Efforts to prevent patients from acquiring an infection or bad outcome while in a hospital require that healthcare workers use infection prevention practices of demonstrated value and monitor the care being provided.

In the broadest sense, infection-monitoring (surveillance) activities are designed to guide **corrective action** based on accurate information, or to provide the rationale for **not acting** when only selective or biased information is available. Poorly designed monitoring activities can, however, waste resources by collecting data that are never used or that fail to provide an accurate picture of what is happening. This occurs most often when surveillance is inconsistent or analysis is incomplete.

Although all healthcare facilities should monitor patient care practices to prevent nosocomial (hospital-acquired) infections and minimize the chance of bad outcomes, surveillance is labor-intensive. As a general rule, monitoring by surveillance should be used only if it will provide specific information not available at less cost. Moreover, it should not consume resources that could be better spent elsewhere. For most facilities with limited resources, the priority should be:

- Ensure recommended infection prevention practices, such as sterilization, or where appropriate HLD, of all items that come in contact with normally sterile tissue, are adhered to.
- Ensure patient care practices are performed according to the best available evidence (i.e., use standard precautions for all patients).
- Monitor compliance with recommended practices for certain high-risk procedures, such as inserting central venous catheters.
- Work to eliminate unnecessary and unsafe injections.

Finally, routine surveillance should not outweigh investigating outbreaks, or providing safe water, food and sanitation within the hospital or healthcare facilities.

WHEN TO CONSIDER PERFORMING SURVEILLANCE

Surveillance should be done only after recommended steps for preventing nosocomial infections have been taken. Only after successfully implementing and monitoring infection prevention practices as described in these guidelines should the recommendation of surveillance be considered.

Casefinding: This could be done by, doing regular clinical review of medical records, talking with patients, discussion with staff, reviewing laboratory findings, and records from the radiology department will provide very useful information in identifying new cases of nosocomial infections. Focusing on specific areas in the hospital (postoperative and postpartum wards, intensive care units for newborn) could be very cost efficient yielding quick results.

Detecting and managing outbreaks: Generally an assistance of qualified epidemiologist is required in order to investigate an outbreak of a nosocomial infection. However, in many instances, the cause of the outbreak can be easily identified and can be resolved without complete investigation.

COMMON MISTAKES IN OUTBREAK INVESTIGATIONS

- There is no clear definition of an outbreak for all disease.
- Isolation of an organism rarely explains an outbreak.
- The presence of organisms from multiple sites or personnel usually suggest that these sites became colonized from another source and were not the cause of the outbreak.
- Negative cultures do not justify concluding that the site was not responsible for the outbreak.
- Prevention measures are not implemented immediately.
- Other similar practices are not evaluated.

Table 20-1 describes the measures identified as effective in investigating outbreaks.

Table 20-1. Measures Identified as Effective in Investigating Outbreaks

SITE	WHERE TO LOOK FOR SOURCE AND/ OR MODE		INTERIM MEASURES
	Common	Uncommon	
Urinary tract infection	<ul style="list-style-type: none"> • Urinary tract instrumentation • Cross-contamination via hands of personnel • Poor hand hygiene 	<ul style="list-style-type: none"> • Inadequately processed instruments • Contaminated antiseptic solution (e.g., povidone-iodine) 	<ul style="list-style-type: none"> • Re-emphasize known aseptic practices relating to insertion and maintenance of urinary catheters, and monitor compliance. • Institute glove use for any contact with urine. • Separate catheterized patients from each other. • Put on clean gloves just before contact with urinary meatus. • Wash hands, or use an antiseptic handrub, after removal of gloves.
Surgical wounds	<ul style="list-style-type: none"> • Organisms acquired intraoperatively by contact with symptomatic or asymptomatic shedders among staff • Contaminated products (wound irrigating solutions) • Poor surgical technique and skills of surgeon (hemostasis, glove puncture) 	<ul style="list-style-type: none"> • Airborne spread • Preoperative contamination (contaminated antiseptic solution) 	<ul style="list-style-type: none"> • Re-emphasize known aseptic practices and surgical technique. • Exclude infected personnel from patient care. • Separate those at risk from those infected. • Put on sterile or high-level disinfected gloves just before wound contact. • Use sterile fluids for wound care. • Wash hands, or use an antiseptic handrub, after removal of gloves. • Improve skills and techniques of the surgeon.
Lower respiratory tract	<ul style="list-style-type: none"> • Colonization of upper airway with secondary aspiration into lung • Contamination of nebulized solutions or respiratory therapy equipment surfaces • Cross-contamination via hands of personnel 	<ul style="list-style-type: none"> • Airborne spread 	<ul style="list-style-type: none"> • Re-emphasize known aseptic practices and surgical technique. • If respiratory therapy is associated with cases, examine technique used for disinfection and delivery of therapies (e.g., multidose vials). • Separate those at risk from those infected. • Put on clean gloves just before contact with mucous membranes and suctioning of patients. • Wash hands, or use an antiseptic handrub, after removal of gloves.
Blood	<ul style="list-style-type: none"> • Intravascular, especially central venous catheters • Contamination of insertion site 	<ul style="list-style-type: none"> • Inadequately processed instruments • Preoperative contamination (contaminated antiseptic solutions) 	<ul style="list-style-type: none"> • Re-emphasize known aseptic practices and surgical technique. • Intravenous catheters should be changed every 96 hours. • Put on sterile or high-level disinfected gloves before inserting catheter and wound contact. • Wash hand, or use an antiseptic handrub, after removal of gloves.

Adapted from: Lynch et al 1997.

REFERENCE

Lynch P et al. 1997. Surveillance, outbreak investigations, and exposures, in *Infection Prevention with Limited Resources*. ETNA Communications: Chicago, pp 31–48.

GLOSSARY

Airborne transmission	Transfer of particles 5 µm or less in size into the air, either as airborne droplets or dust particles containing the infectious microorganism; can be produced by coughing, sneezing, talking or procedures such as bronchoscopy or suctioning; can remain in the air for up to several hours; and can be spread widely within a room or over longer distances. Special air handling and ventilation are needed to prevent airborne transmission.
Animate	Property of having life or being alive (e.g., human tissue or organs).
Antisepsis	Process of reducing the number of microorganisms on skin, mucous membranes or other body tissue by applying an antimicrobial (antiseptic) agent.
Antiseptic or antimicrobial agent (terms used interchangeably)	Chemicals that are applied to the skin or other living tissue to inhibit or kill microorganisms (both transient and resident) thereby reducing the total bacterial counts.
Antiseptic handrub or waterless, alcohol-based antiseptic handrub (terms used interchangeably)	Fast acting antiseptic handrubs that do not require use of water to remove transient flora, reduce resident microorganisms and protect the skin. Most contain 60–90% alcohol, an emollient and often an additional antiseptic (e.g., 2–4% chlorhexidine gluconate) that has residual action.
Asepsis and aseptic technique	Combination of efforts made to prevent entry of microorganisms into any area of the body where they are likely to cause infection. The goal of asepsis is to reduce to a safe level or eliminate the number of microorganisms on both animate (living) surfaces (skin and tissue) and inanimate objects (surgical instruments and other items).
Bactericide	Agent that kills bacteria.
Biosafety level (BSL) guidelines	Combination of primary and secondary containment and safety guidelines designed for use in microbiology laboratories and bacteriology research units functioning at four levels (BSL-1 to BSL-4) of increasing risk.

Biological safety cabinets (BSCs)	Devices that provide protection for personnel, the agent being processed and the environment. They range in complexity from level I (general research cabinets for use with low- to moderate-risk microorganisms) to level III (totally enclosed cabinets with gas-tight construction that provide maximum protection to workers and the environment).
Clean water	Natural or chemically treated and filtered water that is safe to drink and use for other purposes (e.g., handwashing and medical instrument cleaning) because it meets specified public health standards. These standards include: zero levels of microorganisms, such as bacteria (e.g., fecal coliform and <i>Escherichia coli</i>), parasites (e.g., <i>Giardia lamblia</i>) and viruses (e.g., hepatitis A or E); low turbidity (cloudiness due to particulate matter and other contaminants); and minimum levels of disinfectants, disinfectant by-products, inorganic and organic chemicals and radioactive materials. At a minimum clean water should be free of microorganisms and have low turbidity (is clear, not cloudy).
Cleaning	Process that physically removes all visible dust, soil, blood or other body fluids from inanimate objects as well as removing sufficient numbers of microorganisms to reduce risks for those who touch the skin or handle the object.
Cleaning solution	Any combination of soap (or detergent) and water used to wash or wipe down environmental surfaces such as floors, walls, ceilings and furniture.
Clinically significant antibody	Antibody capable of producing an adverse reaction to transfused blood or blood product obtained from a donor (allogenic antibody) or recipient (autologous antibody).
Closed system for obtaining blood	System in which the blood is not exposed to air or outside elements during collection, processing—including separation of components (e.g., platelets) if required prior to transfusion—and storage. It is the safest way to collect, process and store blood.
Colonization	Pathogenic (illness- or disease-causing) organisms are present in a person (i.e., they can be detected by cultures or other tests) but are not causing symptoms or clinical findings (i.e., no cellular changes or damage).
Contact time	Amount of time a disinfectant is in direct contact with the surface or item to be disinfected. For surface disinfection, this time period is framed by the application to the surface until complete drying has occurred.

Contact transmission	Infectious agent (bacteria, virus or parasite) transmitted directly or indirectly from one infected or colonized person to a susceptible host (patient), often on the contaminated hands of a health worker.
Contaminated	State of having been actually or potentially in contact with microorganisms. As used in healthcare, the term generally refers to the presence of microorganisms that could be capable of producing disease or infection.
Corrosion	Action of chemical solutions, such as those containing salt (sodium chloride) or commercial bleach (sodium hypochlorite at concentrations above 0.5%), to cause metal instruments to be gradually eaten away (rusted) with prolonged contact (i.e., more than 1 hour).
Critical medical device (or item)	Devices that penetrate skin or invade normally sterile parts of the body (e.g., central venous catheters). These items contact blood and require sterilization.
Culture	Growth of microorganisms in or on a nutrient medium; to grow microorganisms in or on such a medium.
Decontamination	Process that makes inanimate objects safer to be handled by staff before cleaning (i.e., inactivates HBV, HCV and HIV and reduces, but does not eliminate, the number of other contaminating microorganisms).
Detergents and soaps (terms used interchangeably)	Cleaning products (bar, liquid, leaflet or powder) that lower surface tension, thereby helping remove dirt and debris and transient microorganisms from hands. Plain soaps require friction (scrubbing) to mechanically remove microorganisms while antiseptic (antimicrobial) soaps also kill or inhibit growth of most microorganisms.
Disinfectant	Chemical that destroys or inactivates microorganisms. Disinfectants are classified as low-, intermediate-, or high-level depending on their ability to kill or immobilize some (low- or intermediate-level) or all (high-level) microorganisms (but not all spores). Phenols, chlorine or chlorine-containing compounds and quaternary ammonium compounds (QUATs) are classes of disinfectants frequently used to clean noncritical surfaces such as floors, walls and furniture.
Disinfectant cleaning solution	Products that are a combination of a detergent (soap) and a chemical disinfectant. Not all detergents and disinfectants are compatible. Several combinations are available commercially or can be prepared, such as alkaline detergents with chlorine compounds, alkaline detergents with QUATs or other nonionic surfactants, and acid detergents with iodophors.

Droplet transmission	Contact of the mucous membranes of the nose, mouth or conjunctivae of the eye with infectious particles larger than 5 µm in size and can be produced by coughing, sneezing, talking or procedures such as bronchoscopy or suctioning. Droplet transmission requires close contact between the source and the susceptible person because particles remain airborne briefly and travel only about 3 feet (1 meter) or less.
Dry heat sterilization	Oven that sterilizes metal instruments, glass syringes and bottles and other items by dry heat. Plastic and rubber items cannot be dry-heat sterilized because temperatures used (160–170°C) are too high for these materials.
Encapsulation	Filling a sharps container that is three-quarters full with cement or clay, which, after hardening, can be disposed of safely in a landfill.
Endemic illness or disease	Infectious disease, such as cholera or AIDS, which is continuously present at some level (prevalence) in a particular country or region.
Endometritis	Acute postpartum infection of the lining (endometrium) of the uterus with extension into the smooth muscle wall (myometrium). Clinical features include fever, usually developing on the first or second postpartum day, uterine tenderness, lower abdominal pain, foul-smelling vaginal discharge (lochia) and signs of peritonitis in women who have had a cesarean section.
Endospore or spore (terms used interchangeably)	Relatively water-poor round or elliptical resting cell consisting of condensed cytoplasm and nucleus surrounded by an impervious cell wall or coat. Spores are relatively resistant to disinfectants and sterilants, specifically the bacillus and clostridium species.
Environmental controls	Standards specifying procedures to be followed for the routine care, cleaning and disinfection of environmental surfaces, beds, bedrails, bedside equipment and other frequently touched surfaces.
Epidemic	Rapid spread of an infectious disease, such as cholera, among many individuals in a hospital or community at the same time.
Episiotomy	Surgical cut made in the perineum (usually at the 6 o'clock position) just prior to delivery. The purpose is to facilitate delivery of the presenting part and minimize the risk of injury to the perineal area. Episiotomies are, however, associated with increased bleeding, may extend resulting in increased tearing (3rd or 4th degree perineal laceration), frequently become infected and, most importantly, usually not necessary.

Exposure time	Period of time during a sterilization process in which items are exposed to the sterilant at the specified sterilization parameters. In a steam sterilization process, exposure time is the period during which items are exposed to saturated steam at the specified temperature.
Handwashing	Process of mechanically removing soil and debris from the skin of hands using plain soap and water.
Hazard	Intrinsic potential property or ability of any agent, equipment, material or process that can cause harm.
High-level disinfection (HLD)	Process that eliminates all microorganisms except some bacterial endospores from inanimate objects by boiling, steaming or the use of chemical disinfectants.
Hospital-acquired infection or nosocomial (terms used interchangeably)	Infection that is neither present nor incubating at the time the patient came to the hospital. (Nosocomial refers to the association between care and the subsequent onset of infection. It is a time-related criterion that does not imply a cause and effect relationship.)
Incineration	Controlled burning of solid, liquid or gaseous combustible (burnable) wastes to produce gases and residues containing little or no burnable material.
Infectious microorganisms	Microorganisms capable of producing disease in appropriate hosts.
Infectious waste	The part of medical waste that is capable of causing infectious diseases.
Intermediate-level disinfectant	Agent that destroys all vegetative bacteria, including tubercle bacilli, lipid and some nonlipid viruses, and fungus spores, but not bacterial spores.
Intra-amniotic infection syndrome (IAIS) (also referred to as amnionitis or chorioamnionitis)	Acute clinically detectable infection in the uterus and its contents (fetus, placenta and amniotic fluid) during pregnancy.
Invasive group B streptococcal sepsis	Newborn infection characterized by bacteremia, pneumonia, meningitis and death in up to 25% of infants with the infection. It occurs most commonly following IAIS. Other sites of infection include newborn skin infections (cellulitis) and infections in bones (osteomyelitis).

Laboratory-acquired infection	Nosocomial infection resulting from the performance of laboratory activities by staff, regardless of how it occurred.
Linens	Cloth items used in healthcare facilities by housekeeping staff (bedding and towels), cleaning staff (cleaning cloths, gowns and caps) and surgical personnel (caps, masks, scrub suits, surgical gowns, drapes and wrappers). Also used by staff working in specialty units such as intensive care (ICUs) and other units performing invasive medical procedures (e.g., anesthesiology, radiology, or cardiology).
Low-level disinfectant	Agent that destroys all vegetative bacteria (except tubercle bacilli), lipid viruses, some nonlipid viruses, and some fungus, but not bacterial spores.
Mechanical indicator	Automated devices that monitor the sterilization process (e.g., graphs, gauges, printouts).
Microorganisms	Causative agents of infection. They include bacteria, viruses, fungi and parasites. For infection prevention purposes, bacteria can be further divided into three categories: vegetative (e.g., staphylococcus), mycobacteria (e.g., tuberculosis) and endospores (e.g., tetanus). Of all the common infectious agents, endospores are the most difficult to kill due to their protective coating.
Municipal waste	General waste for collection by municipalities (e.g., local city or town authorities) generated mainly by households, commercial activities and street sweeping.
Mycobacteria	Bacteria with a thick, waxy coat that makes them more resistant to chemical disinfectants than other types of vegetative bacteria.
Noncritical medical device (or item)	Devices that normally make contact with the patient's intact skin (e.g., blood pressure cuff, oxygen masks). These devices require low- to intermediate-level disinfection, and reuse carries little risk.
Nonionic	Neutral (neither positively or negatively charged) particle or substance.
Nonlipid viruses	Viruses consist of a core of nucleic acid is surrounded by a coat of protein. Nonlipid viruses are generally viewed as more resilient to inactivation than lipid viruses. Nonlipid viruses are also referred to as nonenveloped or hydrophilic (water-seeking) viruses.

Nosocomial or hospital-acquired infection (terms used interchangeably)	Infection that is neither present nor incubating at the time the patient came to the hospital. (Nosocomial refers to the association between care and the subsequent onset of infection. It is a time-related criterion that does not imply a cause and effect relationship.)
Nosocomial diarrhea	On at least 2 consecutive days having at least three loose or watery stools with the onset more than 72 hours after admission to the hospital (or more days than the incubation period if the agent is known).
Nosocomial infection in newborns	Infection occurring after birth but excluding those infections known to have been transmitted across the placenta such as congenital syphilis, cytomegalovirus, rubella, varicella (chicken pox) and the protozoan parasite, <i>Toxoplasmosis gondii</i> .
Nosocomial infection in obstetrical patients	Infection that is neither present nor incubating at the time the patient is admitted to the hospital. Most urinary tract infections and endometritis are nosocomial even though the causative organism may be endogenous (i.e., present in the maternal lower genital tract prior to delivery).
Occupational injury or infection	Injury or infection acquired by healthcare staff while performing their normal duties.
Operating room	Area or space where surgical procedures are performed.
Organ/Space SSI	Any part of the body other than the incised body wall parts that were opened or handled during an operation.
Parts per million (ppm)	Concentrations of trace contaminant gases in the air (or chemicals in a liquid) are commonly measured in parts per million (ppm) by volume. To convert percent concentration to ppm and vice versa, use this formula: ppm = percent (%) x 10,000.
Personal protective equipment (PPE)	Specialized clothing or equipment (e.g., gloves, face mask or plastic apron) worn by an employee for protection against exposure to blood or body fluids or other hazards. Uniforms, pants, and shirts not designed to function as protection against a hazard are not considered to be PPE.
Phlebitis	Area of swelling, redness, warmth and tenderness of the skin around the site where the intravascular catheter comes out of the skin (the exit site). If phlebitis is associated with other signs of infection, such as fever and pus coming from the exit site, it is classified as a clinical exit site infection .

Protective barrier	Physical, mechanical or chemical process that helps prevent the spread of infectious microorganisms from person to person (patient, healthcare client or health worker), and from equipment, instruments and environmental surfaces to people.
QUAT	Abbreviated form of the term quaternary ammonium compound; a surface-active, water-soluble, low-level disinfecting substance that has four carbon atoms linked to a nitrogen atom through chemical (covalent) bonds.
Reprocessing	Decontaminating, disassembling (if necessary), cleaning, inspecting, testing, packaging, relabeling, and sterilizing or high-level disinfecting single-use devices (SUDs) after they have been used on a patient for their intended purpose. Reprocessing also is performed on SUDs that were removed from the package (or container) but not used on a patient or whose expiration date has passed.
Resident flora	Microorganisms that live in the deeper layers of the skin, as well as within hair follicles, and cannot be completely removed, even by vigorous washing and rinsing with plain soap and clean water.
Resterilization	Repeat application of a terminal process designed to remove or destroy all viable forms of microbial life, including bacterial spores, to an acceptable sterility assurance level. This process is performed on devices whose expiration date has passed or that have been opened and may or may not have been used on a patient.
Safe Zone (also Neutral Zone)	Device or designated area of the sterile field in which sharps are placed, accessed, returned, and retrieved to avoid hand-to-hand transfer of sharps between personnel.
Sanitary landfill	Engineered method of disposing of solid waste on land in a manner that protects the environment (e.g., by spreading the waste in thin layers, compacting it to the smallest practical volume and then covering it with soil at the end of each working day).
Scavenging	Manual sorting of solid waste at landfills and removal of usable material.
Segregation	Systematic separation of solid waste into designated categories.
Semicritical medical device (or item)	Devices that come in contact with mucous membranes or nonintact skin during use (e.g., endoscopes, respiratory equipment). These devices require high-level disinfection if sterilization is not practical, and reuse carries a greater risk for cross-contamination than noncritical items.

Septic pelvic thrombophlebitis	Thrombosis (blockage) of the deep pelvic veins due to inflammation and blood clots. It is uncommon (approximately 1 in 2000 deliveries). Predisposing factors include cesarean section after long labor (>24 hours), premature rupture of membranes, difficult delivery (forceps or vaginal extraction), anemia and malnutrition.
Sharps	Suture needles, scalpel blades, scissors, wire sutures, broken glass or any object that can cause a puncture or cut.
Soaps and detergents (terms used interchangeably)	Cleaning products (bar, liquid, leaflet or powder) that lower surface tension, thereby helping remove dirt, debris and transient microorganisms from hands. Plain soaps require friction (scrubbing) to mechanically remove microorganisms while antiseptic (antimicrobial) soaps also kill or inhibit growth of most microorganisms.
Soiled or contaminated linen	Linen from multiple sources within the hospital or clinic that has been collected and brought to the laundry for processing. All items, regardless of whether or not they are visibly dirty or have been used in a surgical procedure, must be washed and dried.
Sorting	Process of inspecting and removing foreign, and in some cases dangerous, objects (e.g., sharps or broken glass), from soiled linen before washing. This step is extremely important because soiled linen from the operating room or clinic occasionally contains sharps (e.g., scalpels, sharp-tipped scissors, hypodermic and suture needles and towel clips).
Spaulding classification	Strategy for reprocessing contaminated medical devices. The system classifies medical devices as critical, semicritical, or noncritical based upon the risk from contamination on a device to patient safety.
Spore or endospores (terms used interchangeably)	Relatively water-poor round or elliptical resting cell consisting of condensed cytoplasm and nucleus surrounded by an impervious cell wall or coat. Spores are relatively resistant to disinfectants and sterilants, specifically the bacillus and clostridium species.
Steam sterilization	Sterilization process that uses saturated steam under pressure, for a specified exposure time and at a specific temperature, as the sterilizing agent.

Sterilants	Chemicals used to destroy all forms of microorganisms, including endospores. Most sterilants are also high-level disinfectants when used for a shorter period of time. Sterilants are only used on inanimate objects (e.g., surgical instruments) that are used in semicritical and critical areas (e.g., surgery). Sterilants are not meant to be used for cleaning environmental surfaces.
Sterile or sterility	State of being free from all living microorganisms. In practice, usually described as a probability function (e.g., the probability of a microorganism surviving sterilization as being one in a million).
Sterilization	Process that eliminates all microorganisms (bacteria, viruses, fungi and parasites) including bacterial endospores from inanimate objects by high-pressure steam (autoclave), dry heat (oven), chemical sterilants or radiation.
Sterilizer	Apparatus used to sterilize medical instruments, surgical gloves, equipment or supplies by direct exposure to the sterilizing agent (autoclave or dry-heat oven).
Surfactant	Agent that reduces the surface tension of water or the tension at the interface between water and another liquid; a wetting agent found in many sterilants and disinfectants.
Surgical asepsis	Preparation and maintenance of a reduced (safe) level of microorganisms during an operation by controlling four main sources of infectious organisms: the patient, personnel, equipment and the environment.
Surgical site infections (SSI)	Either an incisional or organ/space infection occurring within 30 days after an operation or within 1 year if an implant is present. Incisional SSIs are further divided into superficial incisional (only involves skin and subcutaneous tissue) and deep incisional (involves deeper soft tissue, including fascia and muscle layers).
Surgical unit	Whole surgical area including lockers and dressing rooms, preoperative and recovery rooms, peripheral support areas including storage space for sterile and high-level disinfected items and other consumable supplies, corridors leading to restricted areas, the operating room(s), scrub sink areas and the nursing station.
Surveillance	Systematic collection of relevant data on patient care, the orderly analysis of the data and the prompt reporting of the data to those who need it. Active surveillance consists of collecting information directly from patients or staff, while passive surveillance includes examining reports, laboratory information and data from other sources.

Transfusion service	Facility or hospital unit that provides storage, pretransfusion testing and cross-matching, and infusion of blood or blood products to intended patients (recipients).
Transient flora	Microorganisms acquired through contact with patients, other healthcare workers or contaminated surfaces (e.g., examination tables, floors or toilets) during the course of the normal workday. These organisms live in the upper layers of the skin and are partially removed by washing with plain soap and clean water.
Unit of blood	Sterile plastic bag in which a fixed volume of blood is collected in a suitable amount of anticoagulant.
Urticarial reaction	Allergic reaction consisting of itching (pruritis), hives, skin rash and/or similar allergic condition occurring during or following a transfusion of blood or blood products.
Vegetative bacteria	Bacteria that are devoid of spores and usually can be readily inactivated by many types of germicides.
Visibly soiled hands	Hands showing visible dirt or are visibly contaminated with blood or body fluids (urine, feces, sputum or vomit).
Waste management	All activities, administrative and operational (including transportation activities), involved in the handling, treatment, conditioning, storage and disposal of waste.
Waterless, alcohol-based antiseptic handrub or antiseptic handrub (terms used interchangeably)	Fast acting antiseptic handrubs that do not require use of water to remove transient flora, reduce resident microorganisms and protect the skin. Most contain 60–90% alcohol, an emollient and often an additional antiseptic (e.g., 2–4% chlorhexidine gluconate) that has residual action.



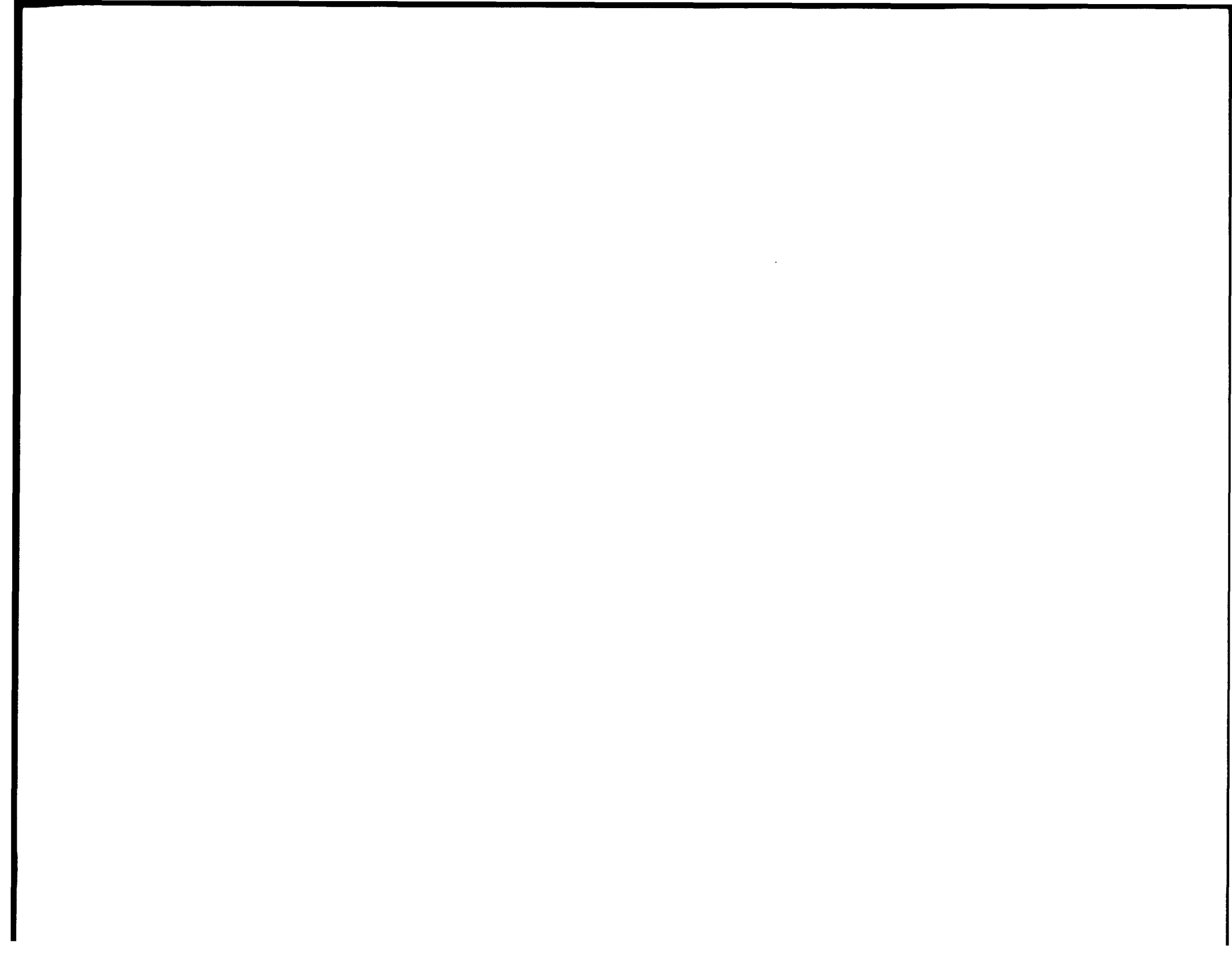

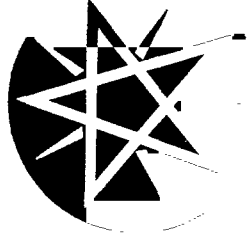

FEDERAL DEMOCRATIC REPUBLIC OF ETHIOPIA
MINISTRY OF HEALTH